



Patent keys  
Chiavi patent  
Patentschlüssel  
Clés patent  
Llaves patent  
Chaves Patent



# IMPORTANT - IMPORTANTE - WICHTIG - IMPORTANT - IMPORTANTE - IMPORTANTE

## GB

**IMPORTANT** - In order to improve service we have updated the information about patent keys in the catalogue.

Where applicable, you will find key references for replacement blanks or for key blanks that can be used in the place of the original one.

### CATALOGUE INDICATIONS:

	Obsolete keys not available from stock.
"REPLACED BY"	Obsolete references with the symbol  are replaced by the key references indicated.
"OBTAINABLE FROM"	Obsolete references with the symbol  can be obtained by machining the key reference indicated.

## D

**WICHTIG** - Zur Verbesserung des Service wurden die Informationen im Katalog bezüglich Patentschlüssel aktualisiert.

Sie finden zu den entsprechenden Artikeln Angaben bezüglich Referenzschlüssel für Ersatzartikel oder Artikel, die als Alternative zum Originalartikel verwendet werden können.

### ANGABEN IM KATALOG:

	Überholte Schlüssel, die nicht mehr auf Lager sind.
"ERSETZT DURCH"	Die durch das Symbol  gekennzeichneten überholten Referenzartikel wurden durch die angegebenen Referenzschlüssel ersetzt.
"ERHÄLTICH MIT"	Die durch das Symbol  gekennzeichneten Referenzartikel sind durch Bearbeitungen der angegebenen Referenzschlüssel erhältlich.

## E

**IMPORTANTE** - Con el fin de mejorar el servicio, hemos puesto al día las informaciones en el catálogo correspondientes a las llaves patent.

Ud. podrá encontrar, en correspondencia con los artículos que las prevén, las referencias llaves de los artículos sustitutivos o las de los artículos que pueden utilizarse como alternativa al artículo originario.

### INDICACIONES EN CATÁLOGO:

	Llaves obsoletas no disponibles en stock.
"SUSTITUIDAS POR"	Las referencias obsoletas marcadas por el símbolo  están sustituidas por las referencias llave indicadas.
"OBTENIBLE CON"	Las referencias obsoletas marcadas por el símbolo  pueden obtenerse, gracias a trabajos específicos, con la referencia llave indicada.

## I

**IMPORTANTE** - Al fine di migliorare il servizio abbiamo aggiornato le informazioni a catalogo relative alle chiavi patent.

Troverete indicate, in corrispondenza degli articoli che le prevedono, le referenze chiavi degli articoli sostitutivi o quelle degli articoli che possono essere utilizzati in alternativa all'articolo originario.

### INDICAZIONI A CATALOGO:

	Chiavi obsolete non disponibili a stock.
"SOSTITUITE DA"	Le referenze obsolete contraddistinte dal simbolo  sono sostituite dalle referenze chiave indicate.
"OTTENIBILI CON"	Le referenze obsolete contraddistinte dal simbolo  sono ottenibili, tramite opportune lavorazioni, con la referenza chiave indicata.

## F

**IMPORTANT** - Dans le but d'améliorer notre service, nous avons mis à jour les informations concernant les clés Patent dans notre catalogue.

Vous trouverez, pour les articles où la chose est prévue, les références clés des articles de remplacement ou celles des articles pouvant être utilisés en alternative à l'article originel.

### LÉGENDES DU CATALOGUE:

	Clés obsolètes non disponibles de stock.
"REPLACÉES PAR"	Les références obsolètes marquées du symbole  sont remplacées par les références clés indiquées.
"REALISABLES PAR"	Les références obsolètes marquées du symbole  sont réalisables, moyennant des usinages particuliers, avec la référence clé indiquée.

## P

**IMPORTANTE** - A fim de melhorar o serviço, no catálogo foram atualizadas as informações relativas às chaves patent.

Estão indicadas, em correspondência dos artigos que as prevêm, as referências chaves dos artigos substitutivos ou as dos artigos que podem ser utilizados em alternativa ao artigo original.

### INDICAÇÕES NO CATÁLOGO:

	Chaves antigas não disponíveis no estoque.
"SUBSTITUÍDAS POR"	As referências antigas marcadas com o símbolo  foram substituídas pelas referências chaves indicadas.
"PODEM SER OBTIDAS COM"	as referências antigas marcadas com o símbolo  podem ser obtidas, por meio de trabalhos adequados, com a referência chave indicada.

FOR:  
PER:

AGB  8

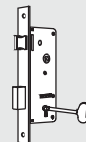

129

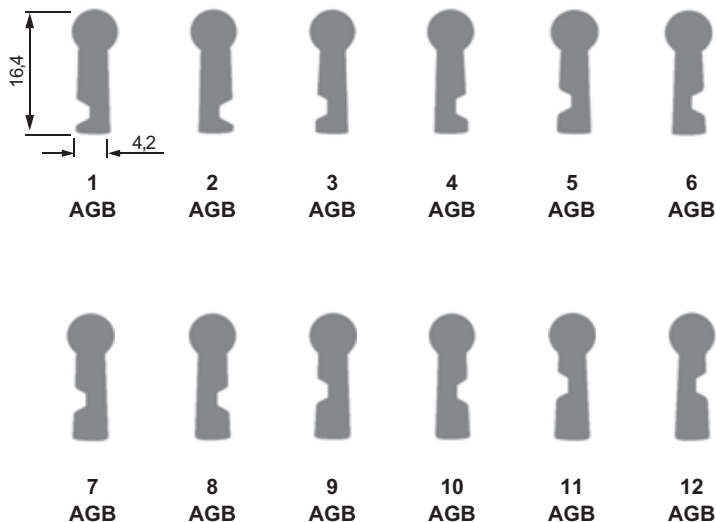
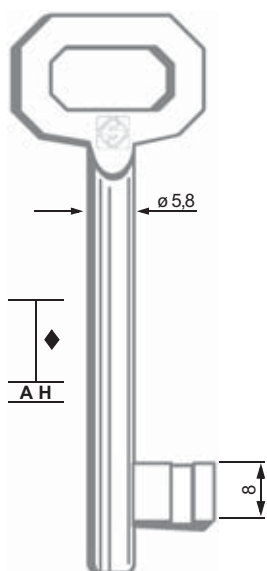

Chiavi obsolete non disponibili a stock - Obsolete keys not available from stock - Überholte Schlüssel, die nicht mehr auf Lager sind - Clés obsolètes non disponibles de stock - Llaves obsoletas no disponibles en stock - Chaves antigas não disponíveis no estoque



Replaced by: / Sostituite da:  
Ersetzt durch: / Remplacées par:  
Substituidas por: / Substituído por:



Obtainable with: / Ottenibili con:  
Realisierbar mit: / Réalisables avec:  
Obtenibles con: / Conseguível com:

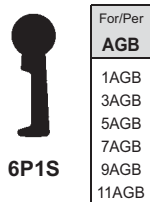
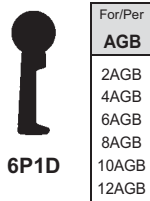
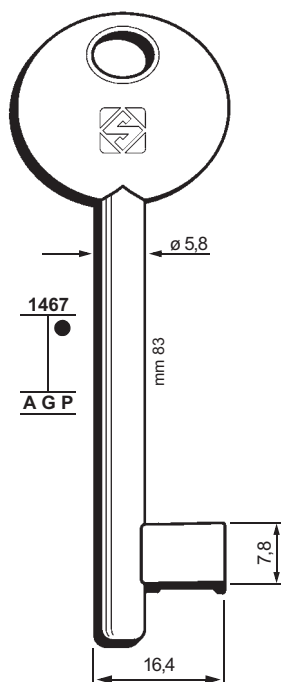

For/Per  
AGB  
2AGB  
4AGB  
6AGB  
8AGB  
10AGB  
12AGB

For/Per  
AGB  
1AGB  
3AGB  
5AGB  
7AGB  
9AGB  
11AGB

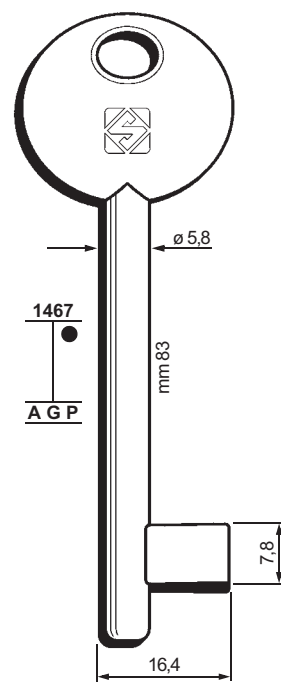

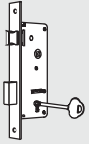

130

FOR:  
PER:

BKS

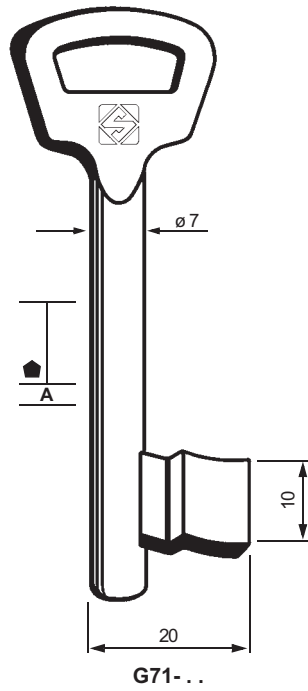

13 1/2



15 1/2



17 1/2



19 1/2



21 1/2



23 1/2



27 1/2



31 1/2

PER:  
FOR:

BKS

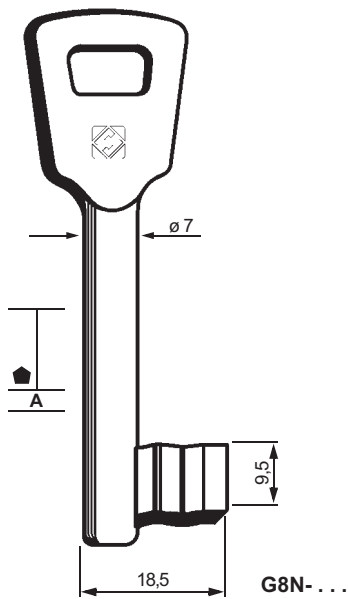

0



1



2



3



4



5



6



7



8



9

FOR:  
PER:

**BONAITI - "GB" ▣ 6**

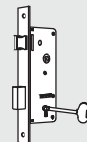

**131**

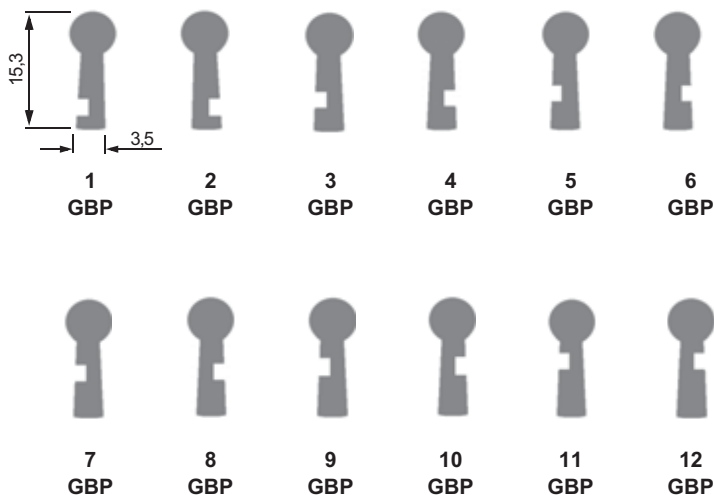
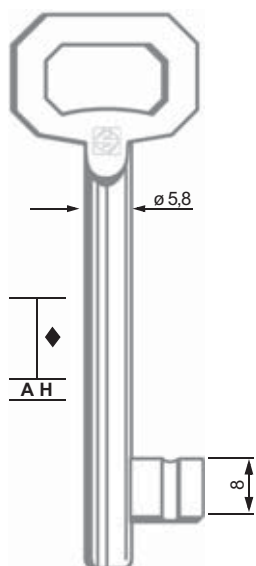

**Chiavi obsolete non disponibili a stock - Obsolete keys not available from stock - Überholte Schlüssel, die nicht mehr auf Lager sind - Clés obsolètes non disponibles de stock - Llaves obsoletas no disponibles en stock - Chaves antigas não disponíveis no estoque**



**Replaced by: / Sostituite da:  
Ersetzt durch: / Remplacées par:  
Substituidas por: / Substituído por:**



**Obtainable with: / Ottenibili con:  
Realisierbar mit: / Réalisables avec:  
Obtenibles con: / Conseguível com:**

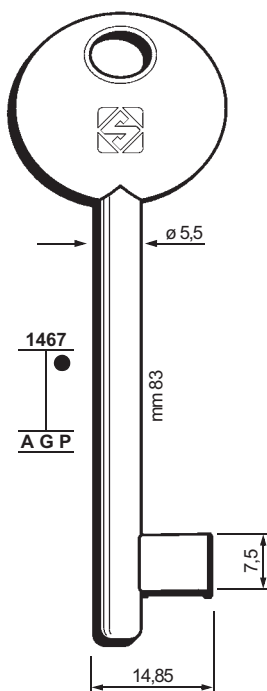

For/Per
<b>BONAITI</b>
2GBP
4GBP
6GBP
8GBP
10GBP
12GBP

For/Per
<b>BONAITI</b>
1GBP
3GBP
5GBP
7GBP
9GBP
11GBP

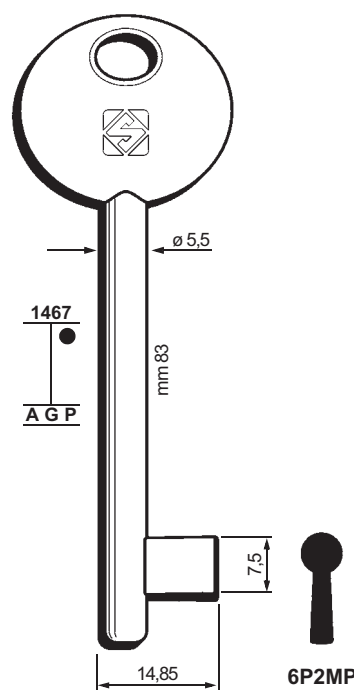

**6P2MP**

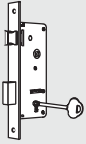

132

FOR:  
PER:

BONAITI - "GB"  $\square$  8

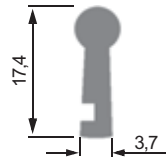
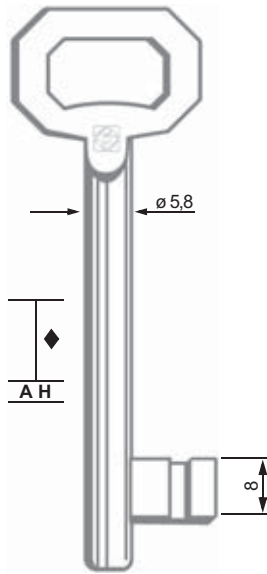

- |          |          |          |           |           |           |
|----------|----------|----------|-----------|-----------|-----------|
| 1<br>GBG | 2<br>GBG | 3<br>GBG | 4<br>GBG  | 5<br>GBG  | 6<br>GBG  |
| 7<br>GBG | 8<br>GBG | 9<br>GBG | 10<br>GBG | 11<br>GBG | 12<br>GBG |



Chiavi obsolete non disponibili a stock - Obsolete keys not available from stock - Überholte Schlüssel, die nicht mehr auf Lager sind - Clés obsolètes non disponibles de stock - Llaves obsoletas no disponibles en stock - Chaves antigas não disponíveis no estoque



Replaced by: / Sostituite da:  
Ersetzt durch: / Remplacées par:  
Substituidas por: / Substituído por:

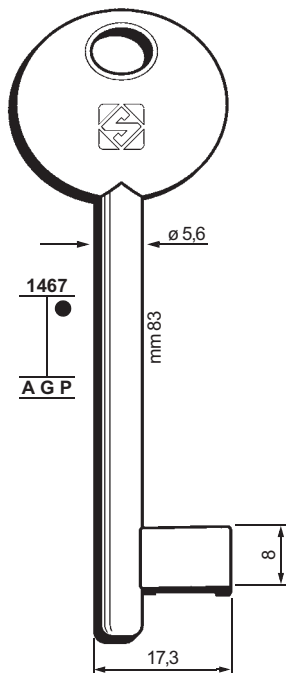

6P3D

For/Per	BONAITI
	2GBG
	4GBG
	6GBG
	8GBG
	10GBG
	12GBG



6P3S

For/Per	BONAITI
	1GBG
	3GBG
	5GBG
	7GBG
	9GBG
	11GBG

FOR:  
PER:

CORNI  6

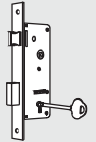

133

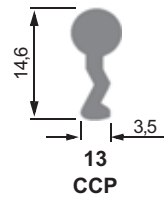
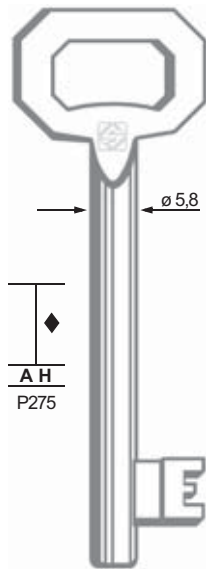
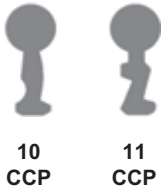
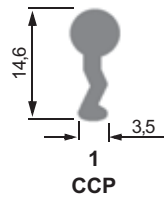
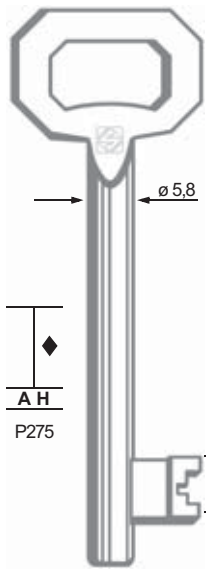

Chiavi obsolete non disponibili a stock - Obsolete keys not available from stock - Überholte Schlüssel, die nicht mehr auf Lager sind - Clés obsolètes non disponibles de stock - Llaves obsoletas no disponibles en stock - Chaves antigas não disponíveis no estoque

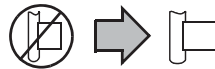

Replaced by: / Sostituite da:  
Ersetzt durch: / Remplacées par:  
Substituidas por: / Substituído por:

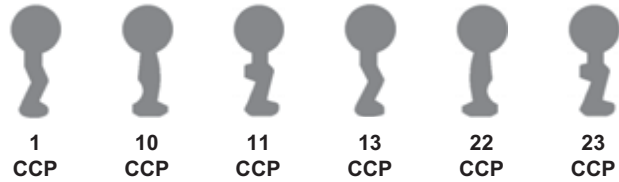
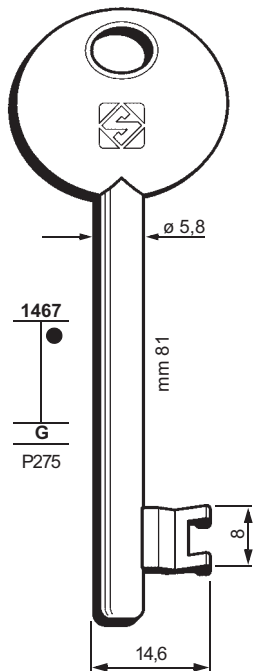

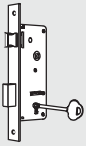

134

FOR:  
PER:

CORNI  $\square$  6

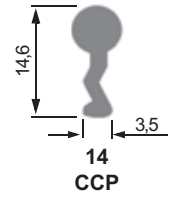
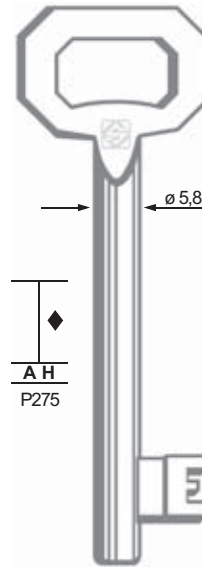
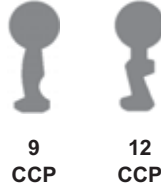
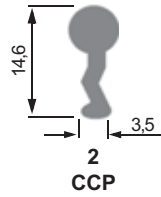
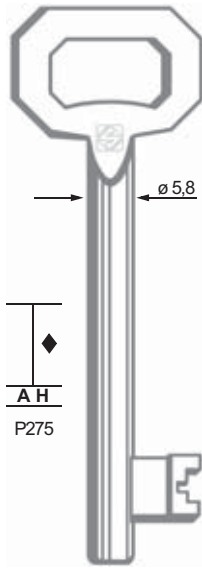

Chiavi obsolete non disponibili a stock - Obsolete keys not available from stock - Überholte Schlüssel, die nicht mehr auf Lager sind - Clés obsolètes non disponibles de stock - Llaves obsoletas no disponibles en stock - Chaves antigas não disponíveis no estoque



Replaced by: / Sostituite da:  
Ersetzt durch: / Remplacées par:  
Substituidas por: / Substituído por:

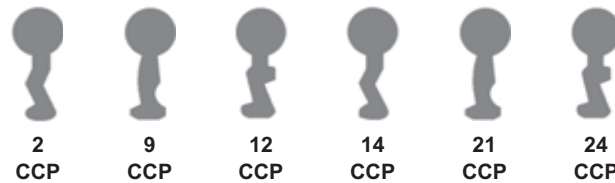
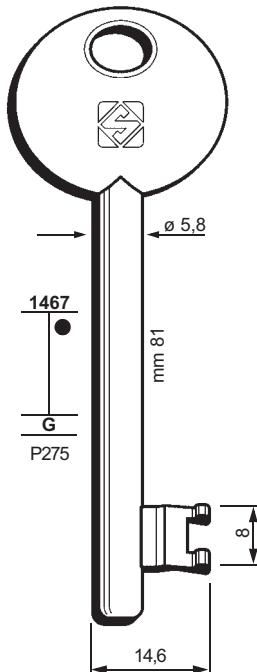





135

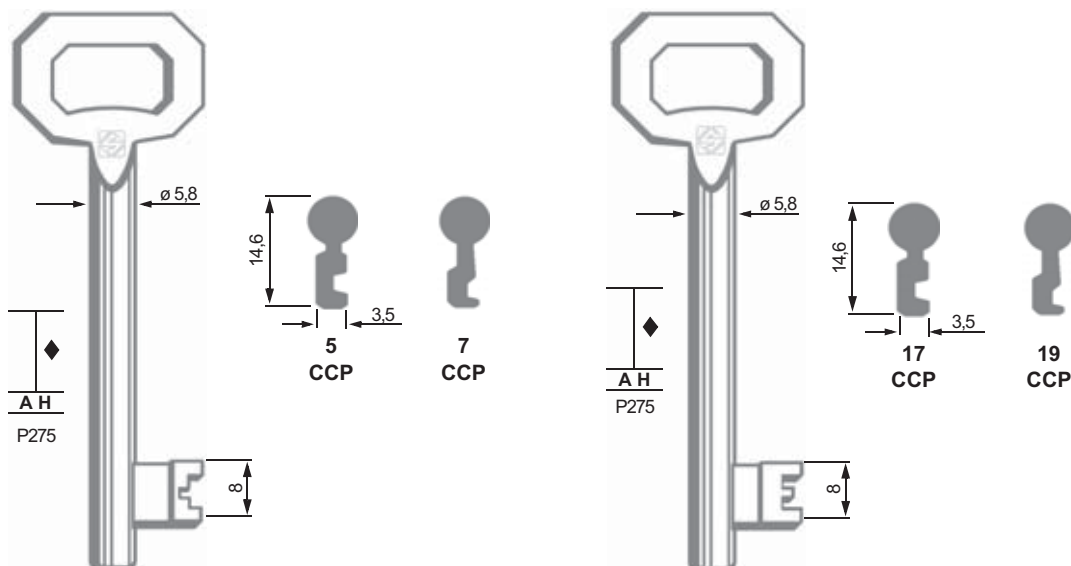

Chiavi obsolete non disponibili a stock - Obsolete keys not available from stock - Überholte Schlüssel, die nicht mehr auf Lager sind - Clés obsolètes non disponibles de stock - Llaves obsoletas no disponibles en stock - Chaves antigas não disponíveis no estoque



Replaced by: / Sostituite da:  
Ersetzt durch: / Remplacées par:  
Substituidas por: / Substituído por:

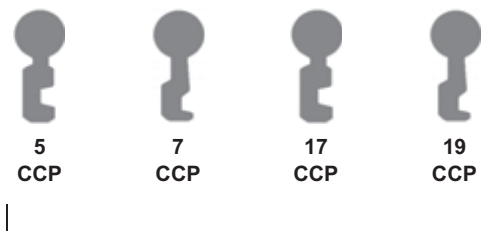
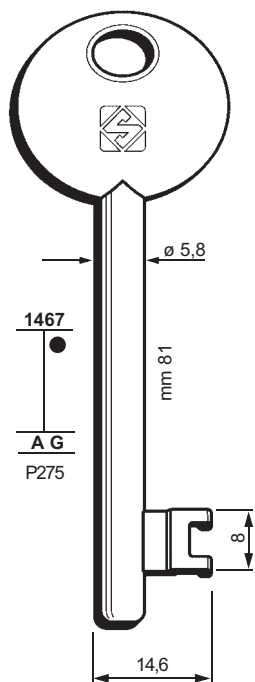

6P10D-1

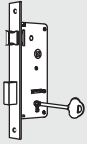

FOR:  
PER:

CORNI  6

136

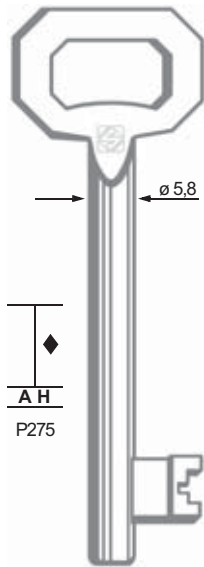

A H  
P275

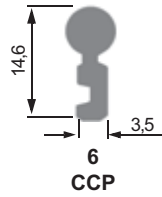

6  
CCP



8  
CCP

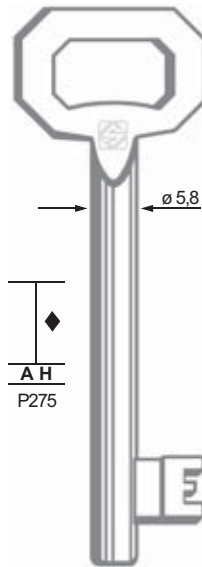

A H  
P275

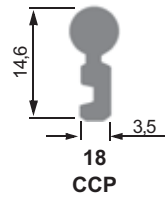

18  
CCP



20  
CCP



Chiavi obsolete non disponibili a stock - Obsolete keys not available from stock - Überholte Schlüssel, die nicht mehr auf Lager sind - Clés obsolètes non disponibles de stock - Llaves obsoletas no disponibles en stock - Chaves antigas não disponíveis no estoque

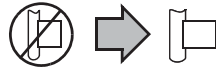

Replaced by: / Sostituite da:  
Ersetzt durch: / Remplacées par:  
Substituidas por: / Substituído por:

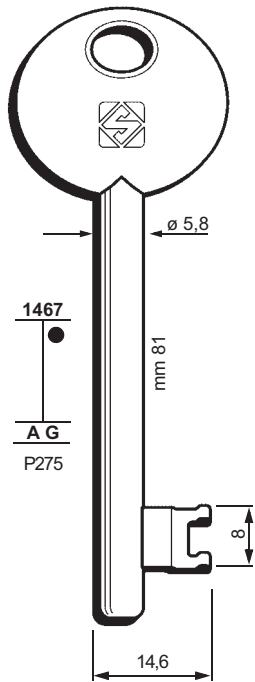

1467  
A G  
P275

mm 81

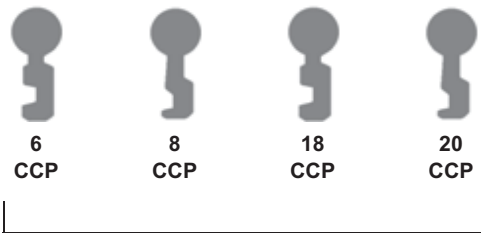

6P10S-1



137

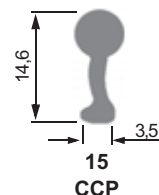
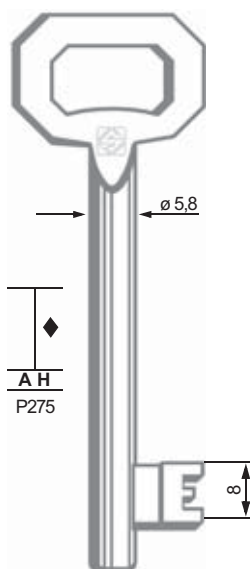
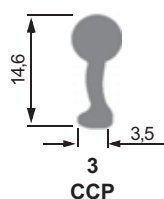
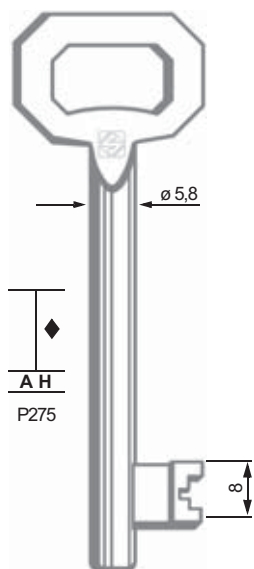

Chiavi obsolete non disponibili a stock - Obsolete keys not available from stock - Überholte Schlüssel, die nicht mehr auf Lager sind - Clés obsolètes non disponibles de stock - Llaves obsoletas no disponibles en stock - Chaves antigas não disponíveis no estoque



Replaced by: / Sostituite da:  
Ersetzt durch: / Remplacées par:  
Substituidas por: / Substituído por:

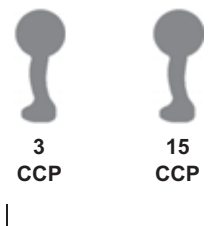
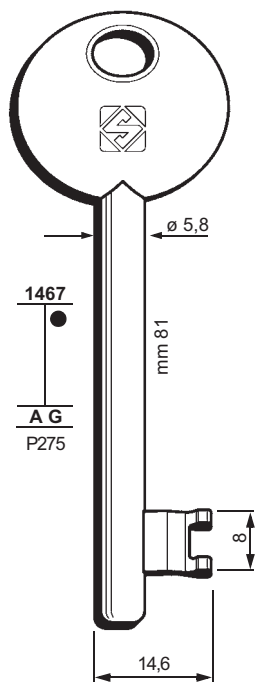

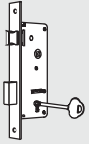

138

FOR:  
PER:

CORNI  $\square$  6

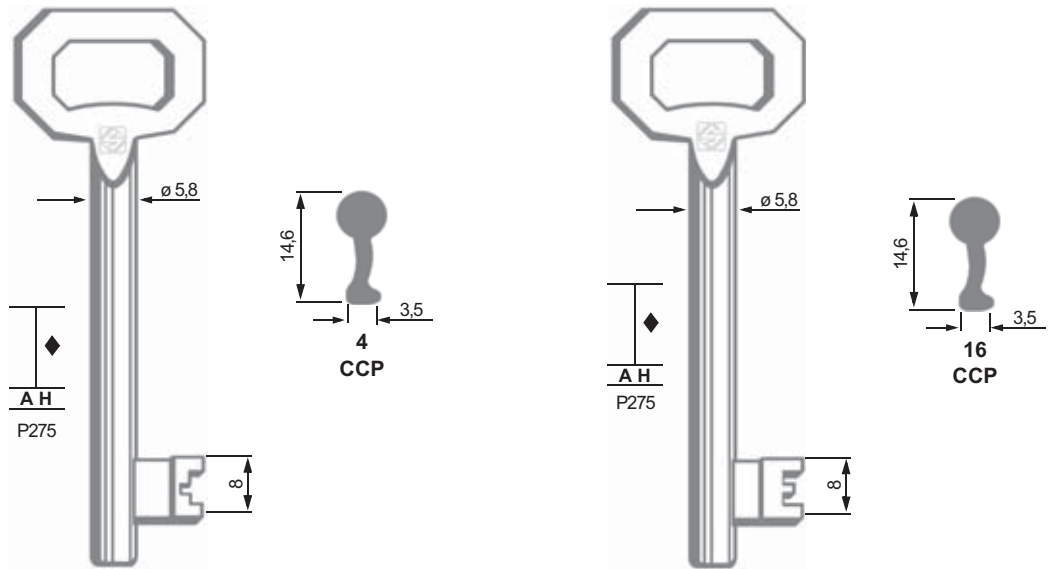

Chiavi obsolete non disponibili a stock - Obsolete keys not available from stock - Überholte Schlüssel, die nicht mehr auf Lager sind - Clés obsolètes non disponibles de stock - Llaves obsoletas no disponibles en stock - Chaves antigas não disponíveis no estoque

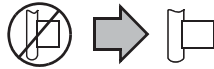

Replaced by: / Sostituite da:  
Ersetzt durch: / Remplacées par:  
Substituidas por: / Substituído por:

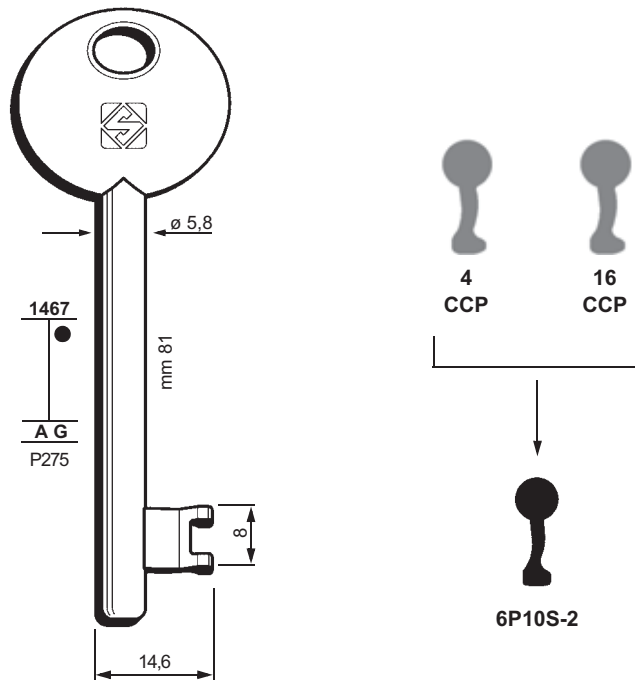

FOR:  
PER:

CORNI  8



139

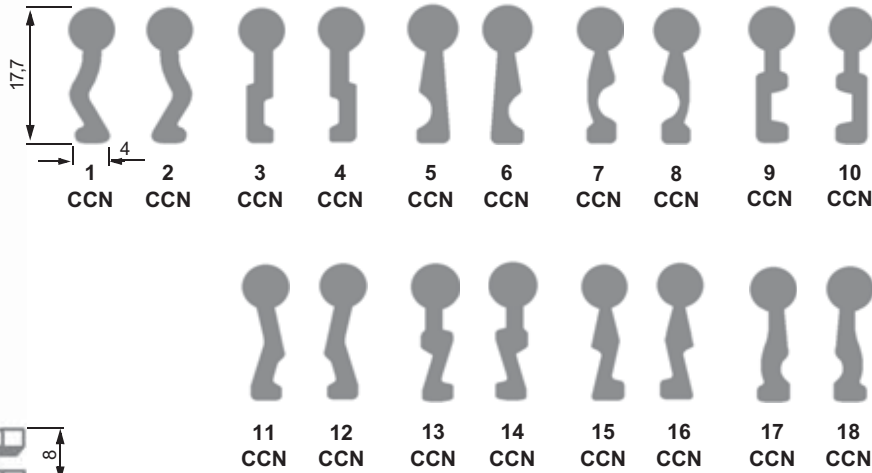
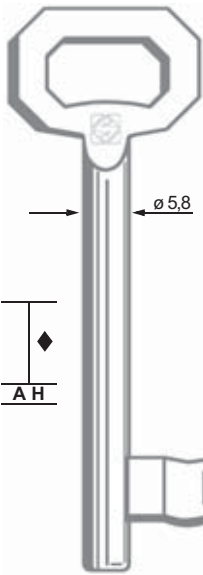

A H



Chiavi obsolete non disponibili a stock - Obsolete keys not available from stock - Überholte Schlüssel, die nicht mehr auf Lager sind - Clés obsolètes non disponibles de stock - Llaves obsoletas no disponibles en stock - Chaves antigas não disponíveis no estoque



Replaced by: / Sostituite da:  
Ersetzt durch: / Remplacées par:  
Substituidas por: / Substituído por:

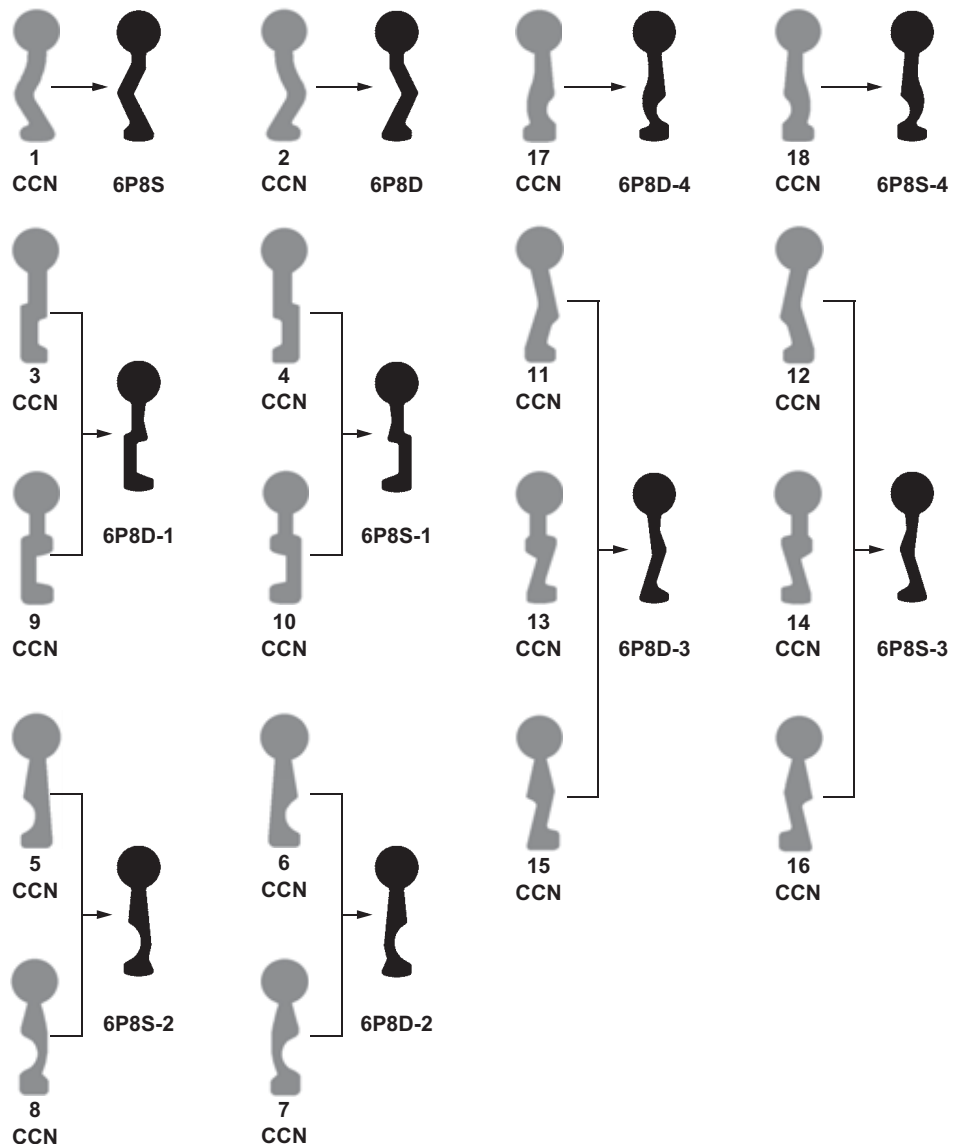
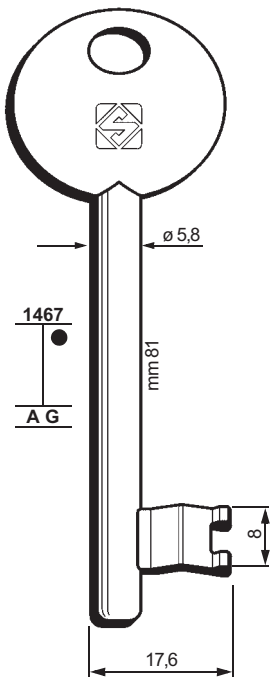

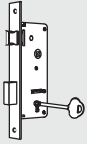

140

FOR:  
PER:

CORNI 8

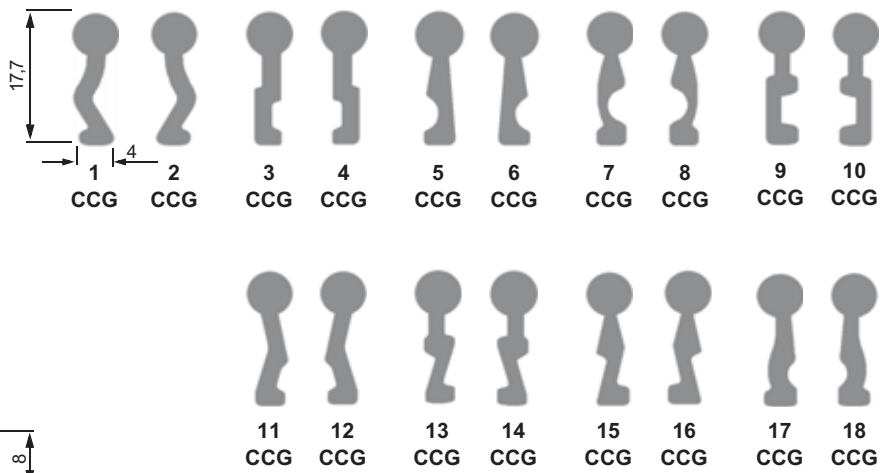
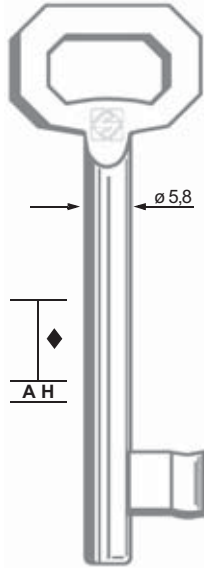

Chiavi obsolete non disponibili a stock - Obsolete keys not available from stock - Überholte Schlüssel, die nicht mehr auf Lager sind - Clés obsolètes non disponibles de stock - Llaves obsoletas no disponibles en stock - Chaves antigas não disponíveis no estoque



Replaced by: / Sostituite da:  
Ersetzt durch: / Remplacées par:  
Substituidas por: / Substituído por:

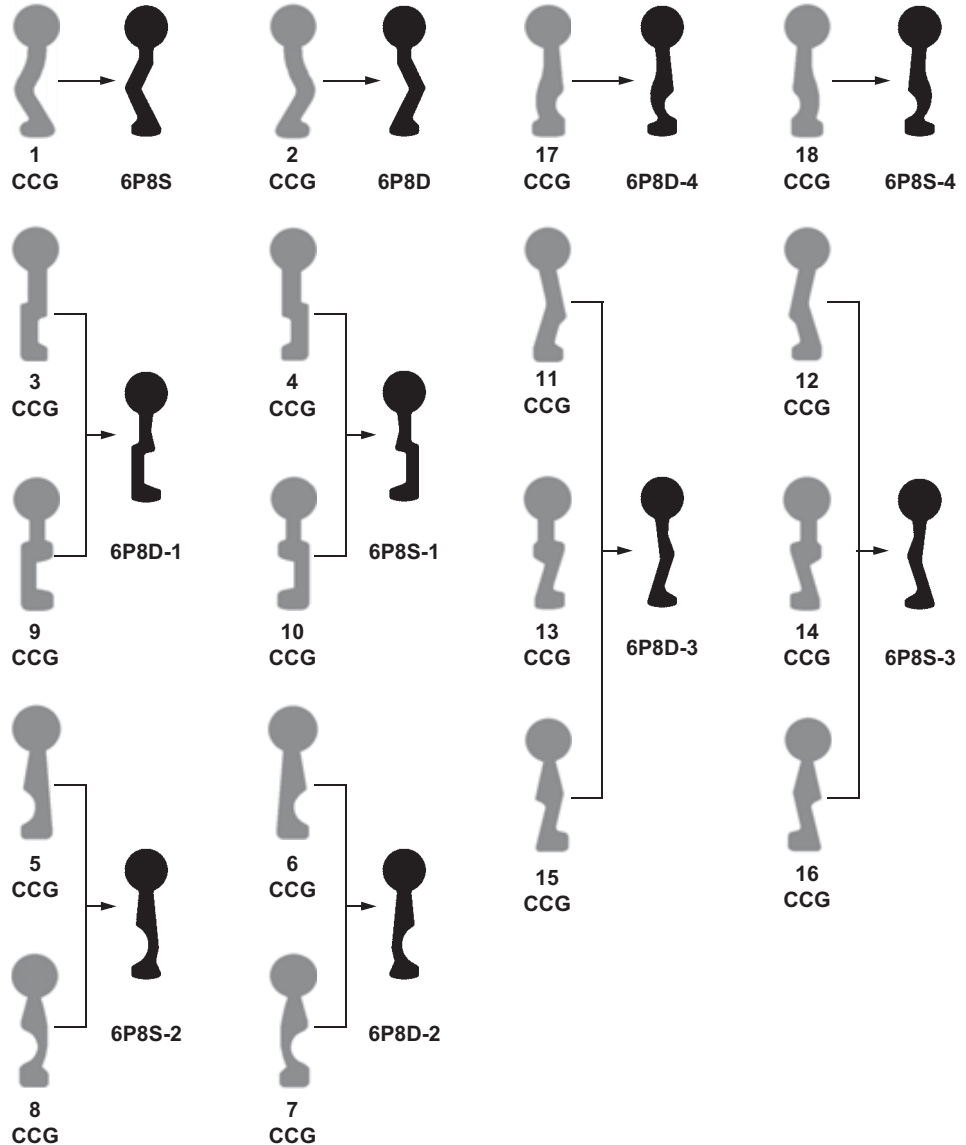
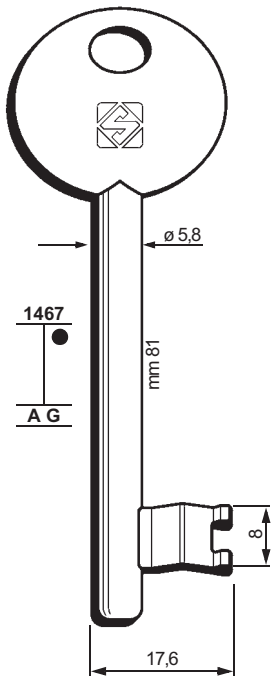

FOR:  
PER:

CORNI  8

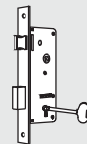

141

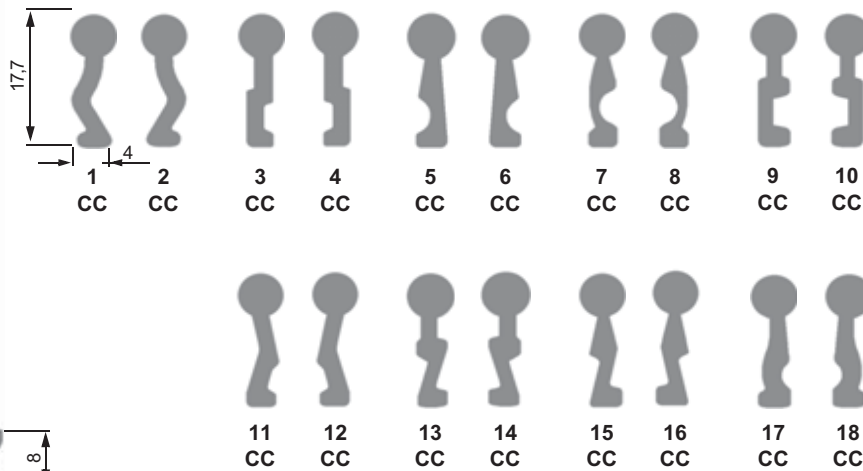
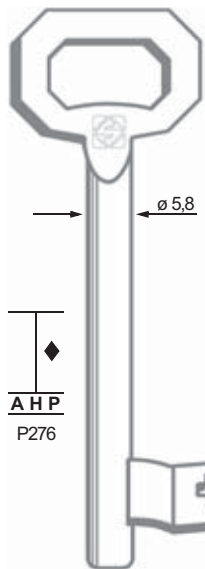

Chiavi obsolete non disponibili a stock - Obsolete keys not available from stock - Überholte Schlüssel, die nicht mehr auf Lager sind - Clés obsolètes non disponibles de stock - Llaves obsoletas no disponibles en stock - Chaves antigas não disponíveis no estoque



Replaced by: / Sostituite da:  
Ersetzt durch: / Remplacées par:  
Substituidas por: / Substituído por:

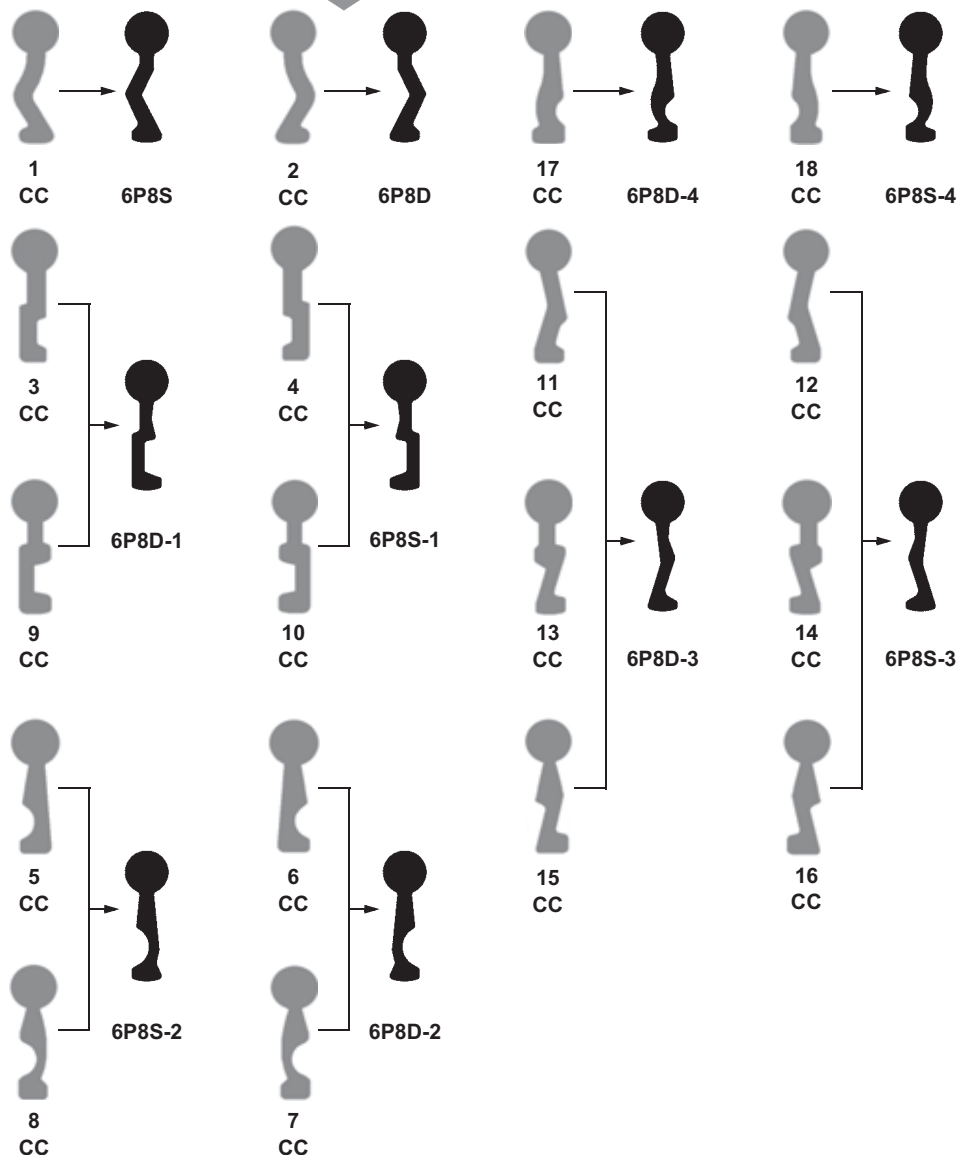
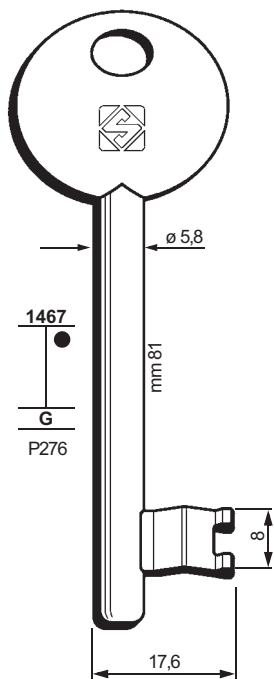



FOR:  
PER:

CORNI  8

142

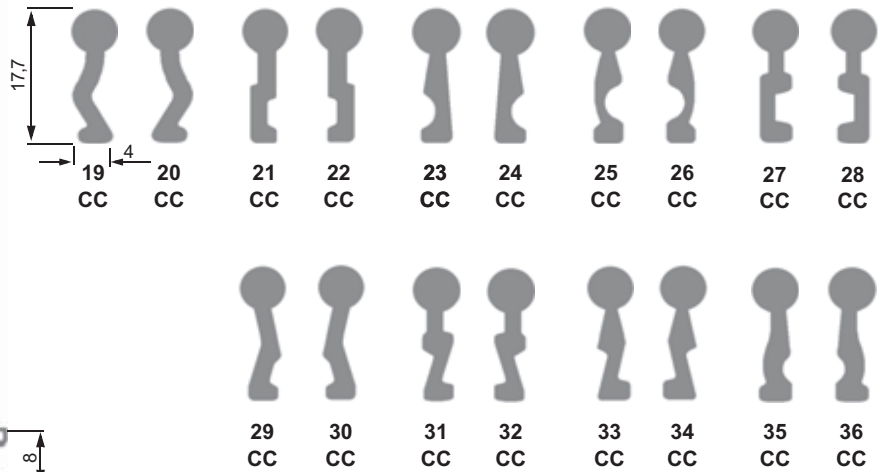
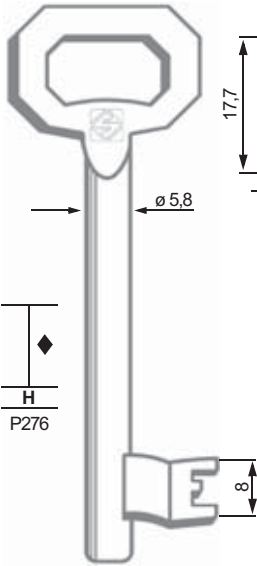

Chiavi obsolete non disponibili a stock - Obsolete keys not available from stock - Überholte Schlüssel, die nicht mehr auf Lager sind - Clés obsolètes non disponibles de stock - Llaves obsoletas no disponibles en stock - Chaves antigas não disponíveis no estoque



Replaced by: / Sostituite da:  
Ersetzt durch: / Remplacées par:  
Substituidas por: / Substituído por:

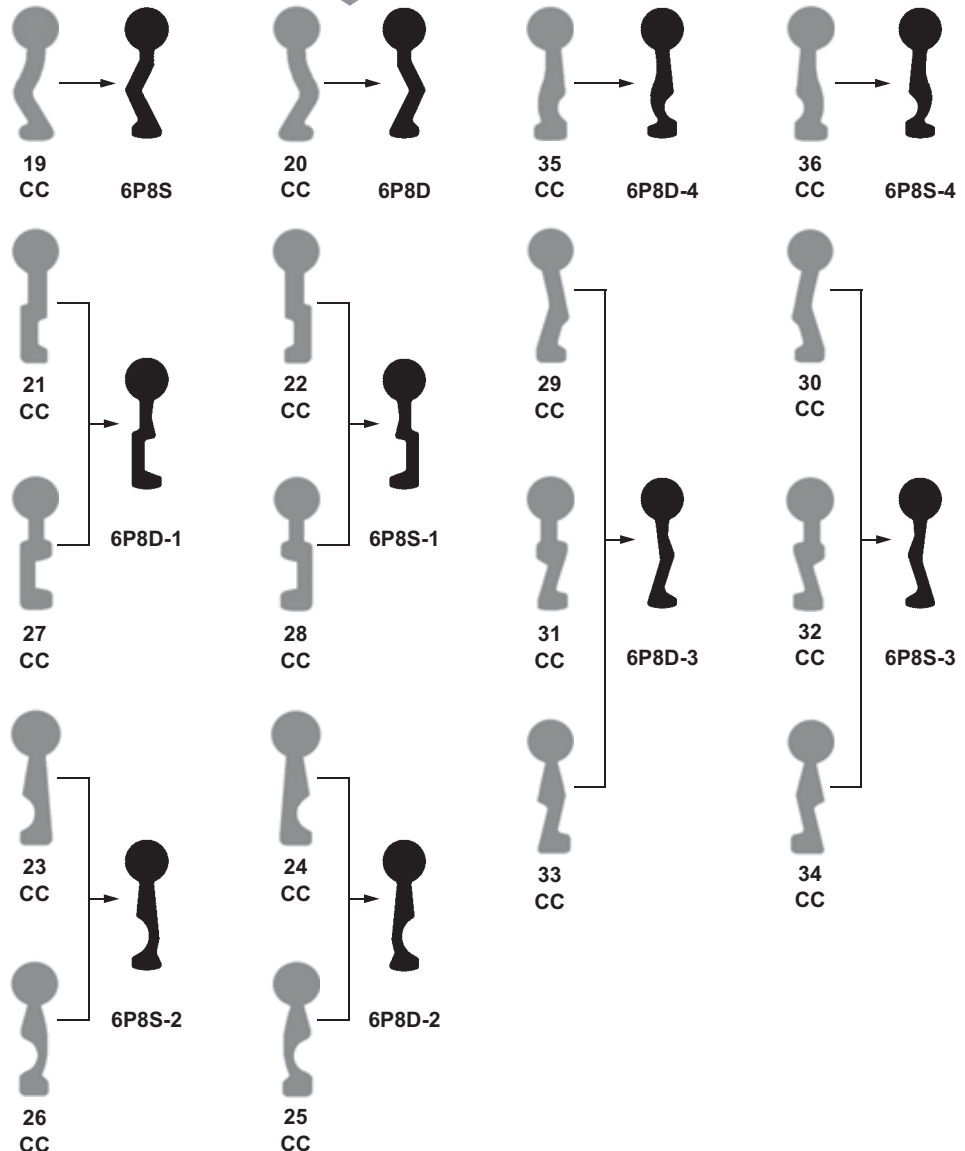
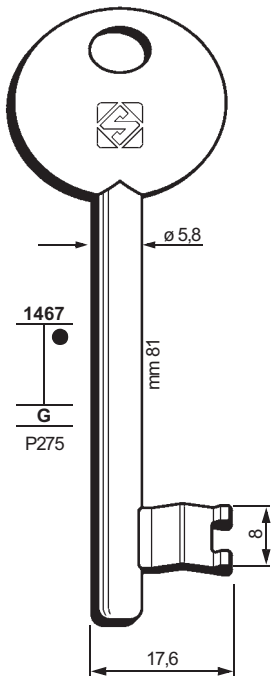











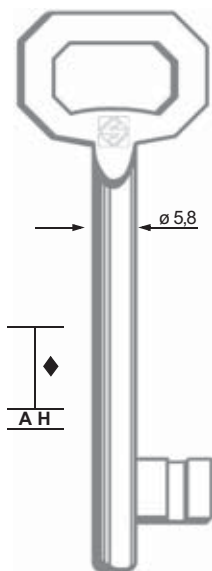

FOR:  
PER:

**CORNI**  **8**



**143**



						
Art. Silca →	1 MPN	2 MPN	5 MPN	6 MPN	7 MPN	8 MPN
Corni orig. →	51	52	53	54	55	56
						
	9 MPN	10 MPN	11 MPN	12 MPN		
	57	58	59	60		



**Chiavi obsolete non disponibili a stock - Obsolete keys not available from stock - Überholte Schlüssel, die nicht mehr auf Lager sind - Clés obsolètes non disponibles de stock - Llaves obsoletas no disponibles en stock - Chaves antigas não disponíveis no estoque**



**Replaced by: / Sostituite da:  
Ersetzt durch: / Remplacées par:  
Substituidas por: / Substituído por:**



**Obtainable with: / Ottenibili con:  
Realisierbar mit: / Réalisables avec:  
Obtenibles con: / Conseguível com:**

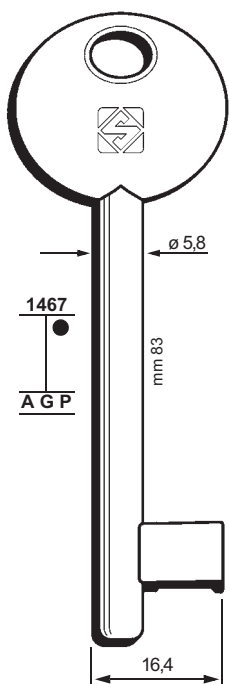

**6P1D**

For/Per
<b>CORN</b>
1MPN
5MPN
7MPN
9MPN
11MPN

**6P1S**

For/Per
<b>CORN</b>
2MPN
6MPN
8MPN
10MPN
12MPN

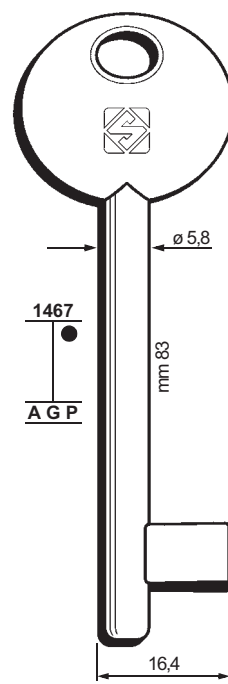

**6P1MP**

For/Per
<b>CORN</b>
2MPN
6MPN
8MPN
10MPN
12MPN

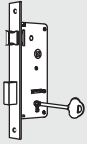

FOR:  
PER:

# DEBEAURAIN

# 144

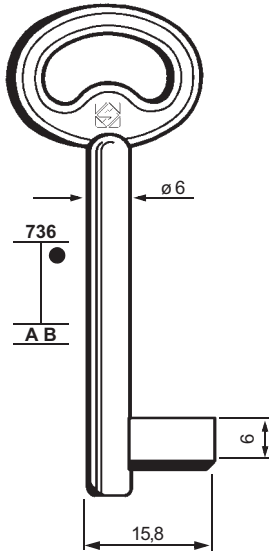

PER:  
FOR:

# EUREKA

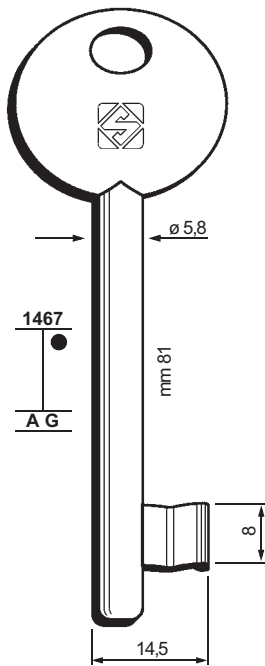

FOR:  
PER:

# GEGE

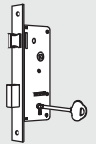

# 145

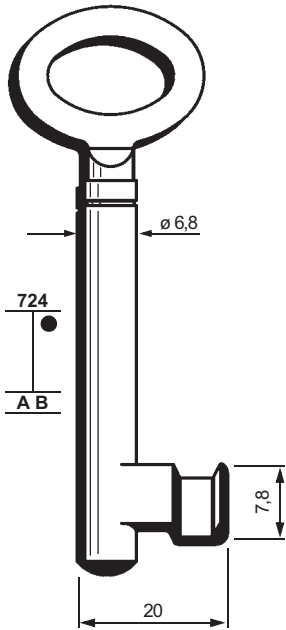

GE700-2



GE700-4



GE700-5



GE700-6



GE700-8



GE700-12



GE700-14



GE700-15



GE700-17



GE700-19



GE700-21



GE700-22



GE700-23



GE700-24



GE700-25



GE700-27



GE700-28



GE700-29



GE700-30



GE700-32



GE700-33



GE700-34



GE700-35



GE700-36



GE700-38



GE700-39



GE700-40



GE700-41



GE700-42



GE700-43



GE700-44



GE700-45



GE700-47



GE700-48



GE700-49



GE700-51



GE700-52



GE700-53



GE700-54



GE700-55



GE700-56



GE700-57



GE700-58



GE700-59



GE700-60

FOR:  
PER:

# LAPERCHE

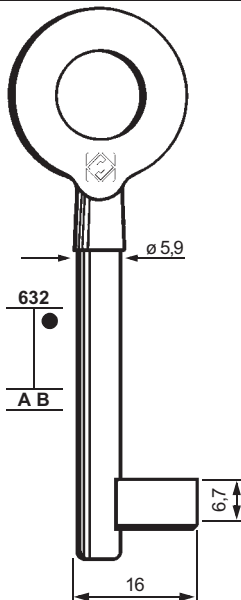

LH710L-3



LH710L-4



LH710L-5



LH710L-6



LH710L



LH710L-9



LH710L-10

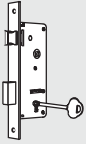

FOR:  
PER:

MAVE

146

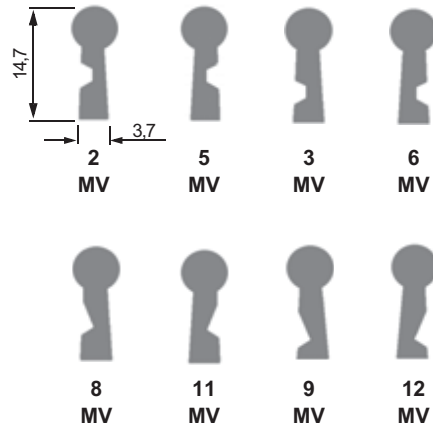
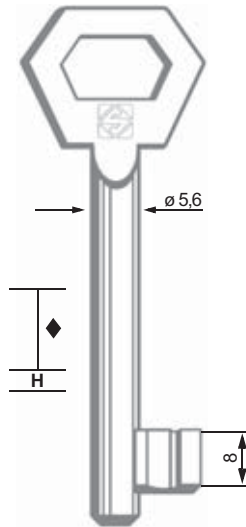

Chiavi obsolete non disponibili a stock - Obsolete keys not available from stock - Überholte Schlüssel, die nicht mehr auf Lager sind - Clés obsolètes non disponibles de stock - Llaves obsoletas no disponibles en stock - Chaves antigas não disponíveis no estoque

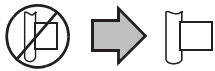

Replaced by: / Sostituite da:  
Ersetzt durch: / Remplacées par:  
Substituidas por: / Substituído por:



Obtainable with: / Ottenibili con:  
Realisierbar mit: / Réalisables avec:  
Obtenibles con: / Consequível com:

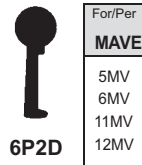
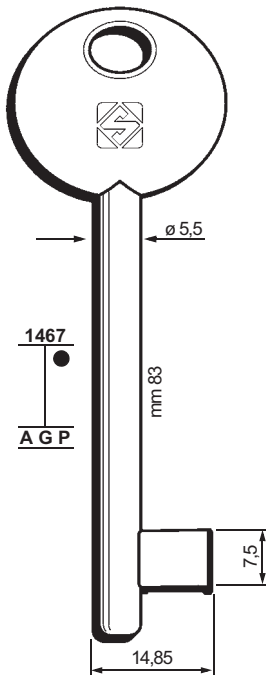

For/Per  
MAVE  
5MV  
6MV  
11MV  
12MV



For/Per  
MAVE  
2MV  
3MV  
8MV  
9MV

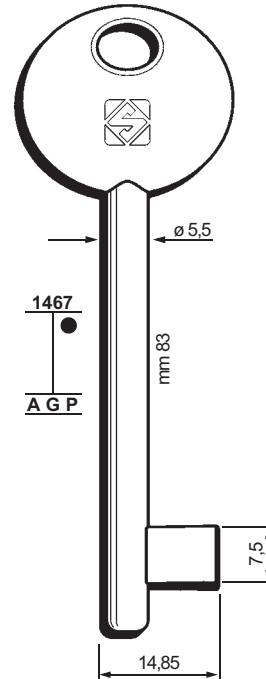

6P2MP

FOR:  
PER:

# MG - (MONTI per cancello)

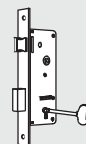

# 147

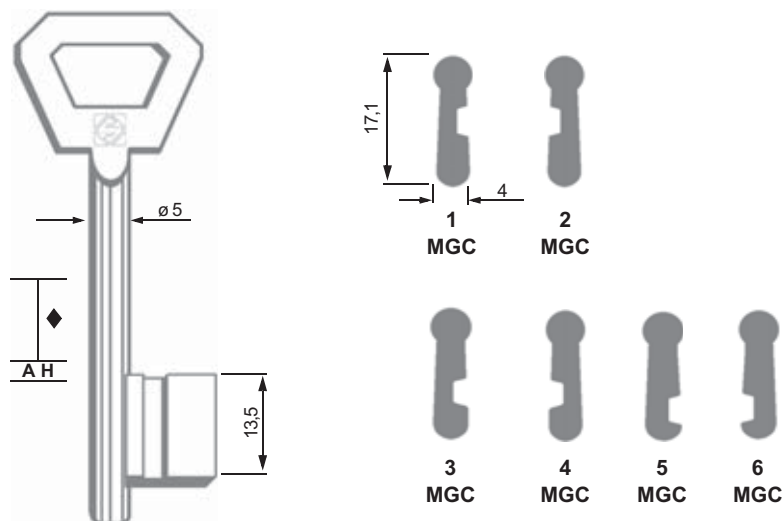

Chiavi obsolete non disponibili a stock - Obsolete keys not available from stock - Überholte Schlüssel, die nicht mehr auf Lager sind - Clés obsolètes non disponibles de stock - Llaves obsoletas no disponibles en stock - Chaves antigas não disponíveis no estoque



Obtainable with: / Ottenibili con:  
Realisierbar mit: / Réalisables avec:  
Obtenibles con: / Conseguível com:

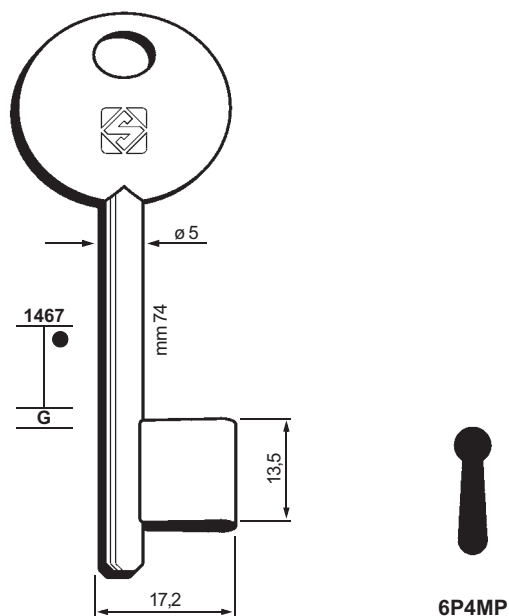

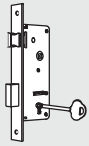

148

FOR:  
PER:

MP

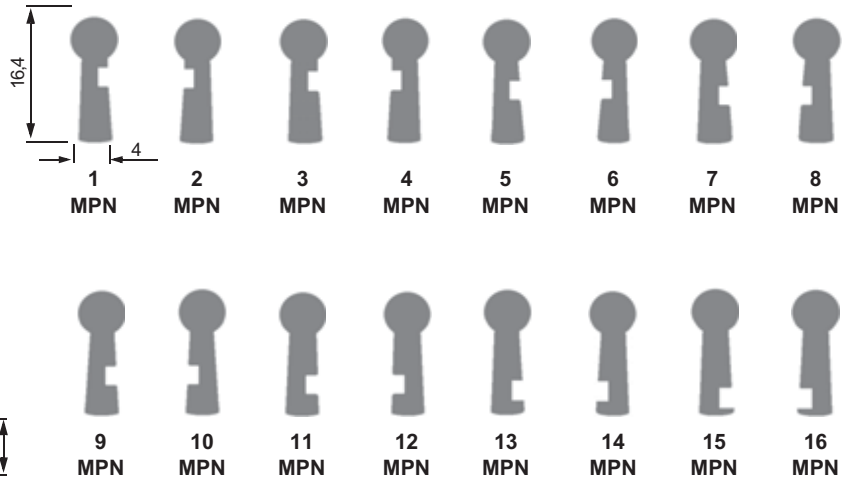
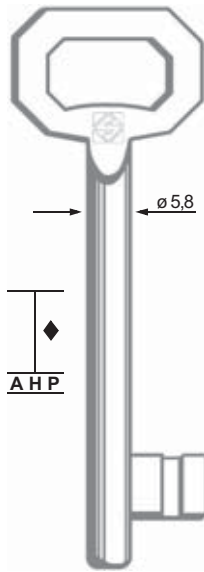

Chiavi obsolete non disponibili a stock - Obsolete keys not available from stock - Überholte Schlüssel, die nicht mehr auf Lager sind - Clés obsolètes non disponibles de stock - Llaves obsoletas no disponibles en stock - Chaves antigas não disponíveis no estoque

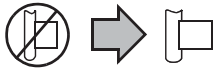

Replaced by: / Sostituite da:  
Ersetzt durch: / Remplacées par:  
Substituidas por: / Substituído por:



Obtainable with: / Ottenibili con:  
Realisierbar mit: / Réalisables avec:  
Obtenibles con: / Conseguível com:

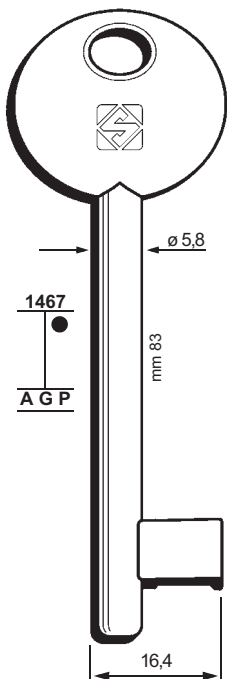

For/Per
MP
1MPN
3MPN
5MPN
7MPN
9MPN
11MPN
13MPN
15MPN

For/Per
MP
2MPN
4MPN
6MPN
8MPN
10MPN
12MPN
14MPN
16MPN

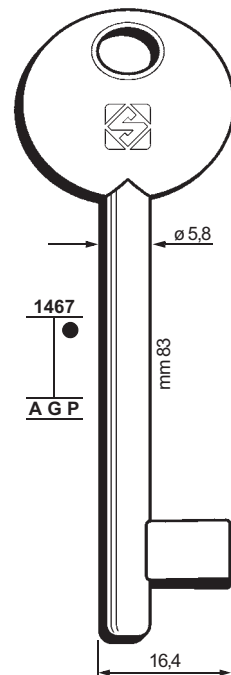

FOR:  
PER:

MP

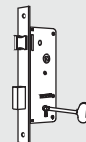

149

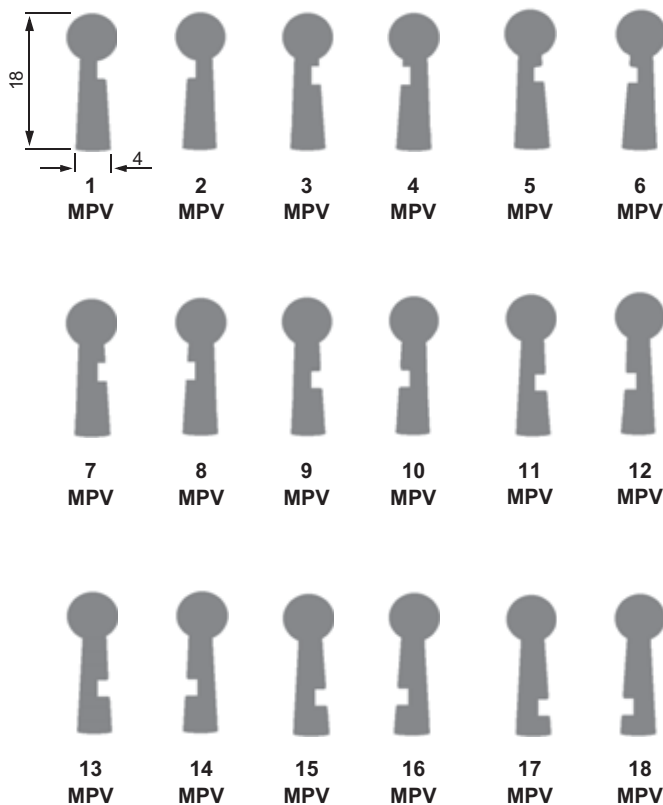
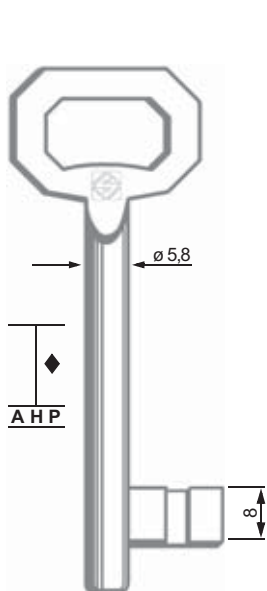

Chiavi obsolete non disponibili a stock - Obsolete keys not available from stock - Überholte Schlüssel, die nicht mehr auf Lager sind - Clés obsolètes non disponibles de stock - Llaves obsoletas no disponibles en stock - Chaves antigas não disponíveis no estoque



Replaced by: / Sostituite da:  
Ersetzt durch: / Remplacées par:  
Substituidas por: / Substituído por:



Obtainable with: / Ottenibili con:  
Realisierbar mit: / Réalisables avec:  
Obtenibles con: / Conseguível com:

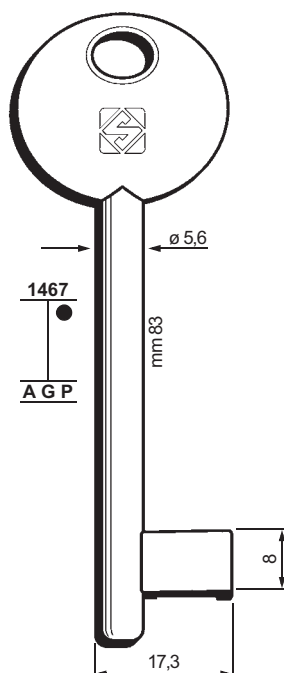

For/Per	MPV
1MPV	
3MPV	
5MPV	
7MPV	
9MPV	
11MPV	
13MPV	
15MPV	
17MPV	

For/Per	MPV
2MPV	
4MPV	
6MPV	
8MPV	
10MPV	
12MPV	
14MPV	
16MPV	
18MPV	

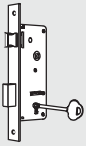

150

FOR:  
PER:

### MP 4 LEVE

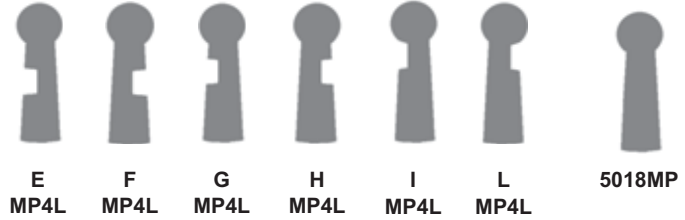
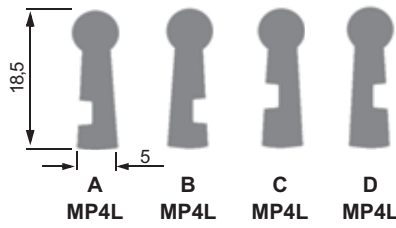
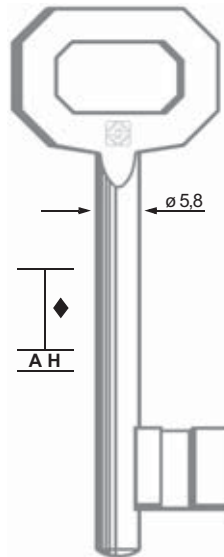

Chiavi obsolete non disponibili a stock - Obsolete keys not available from stock - Überholte Schlüssel, die nicht mehr auf Lager sind - Clés obsolètes non disponibles de stock - Llaves obsoletas no disponibles en stock - Chaves antigas não disponíveis no estoque

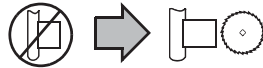

Obtainable with: / Ottenibili con:  
Realisierbar mit: / Réalisables avec:  
Obtenibles con: / Conseguível com:

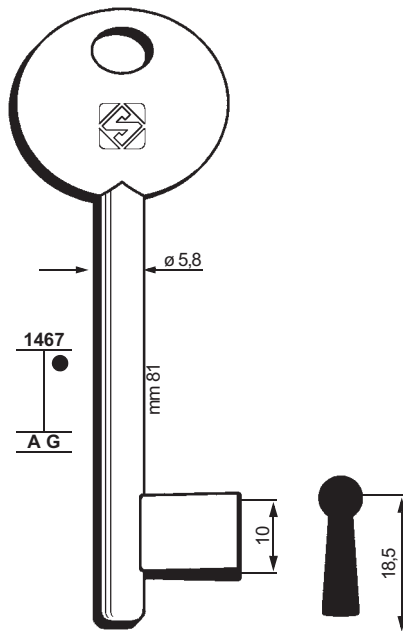

6P9MP



FOR:  
PER:

# NEMEF

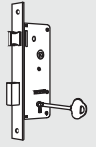

# 151

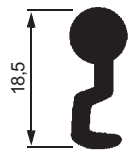
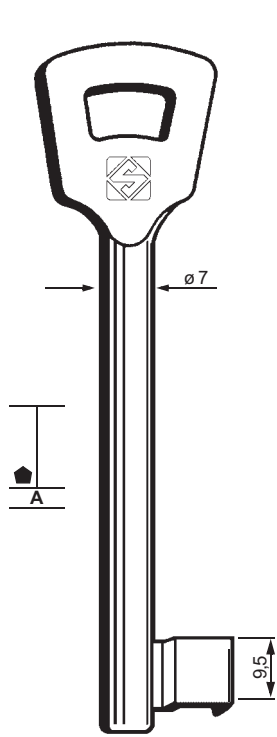

1  
NFHL



2  
NFHL



3  
NFHL



4  
NFHL



5  
NFHL



6  
NFHL



7  
NFHL



8  
NFHL



9  
NFHL



10  
NFHL

FOR:  
PER:

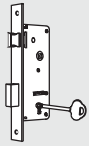

FOR:  
PER:

OASA

152

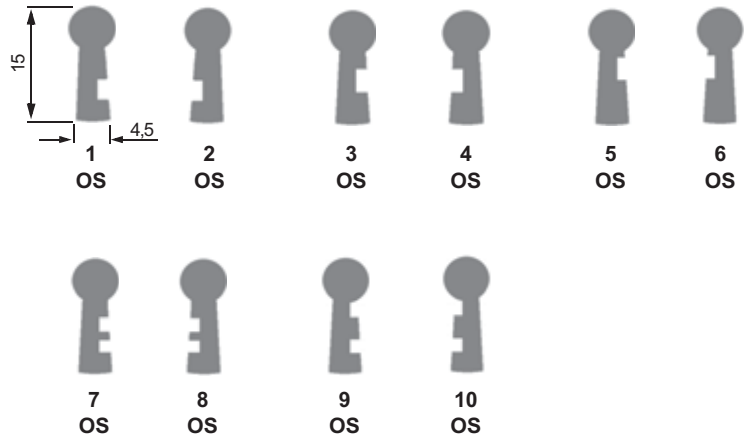
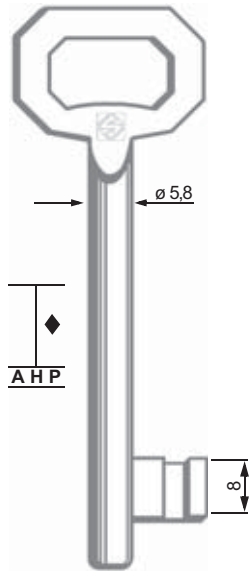

Chiavi obsolete non disponibili a stock - Obsolete keys not available from stock - Überholte Schlüssel, die nicht mehr auf Lager sind - Clés obsolètes non disponibles de stock - Llaves obsoletas no disponibles en stock - Chaves antigas não disponíveis no estoque

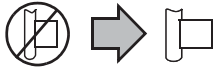

Replaced by: / Sostituite da:  
Ersetzt durch: / Remplacées par:  
Substituidas por: / Substituído por:



Obtainable with: / Ottenibili con:  
Realisierbar mit: / Réalisables avec:  
Obtenibles con: / Consequível com:

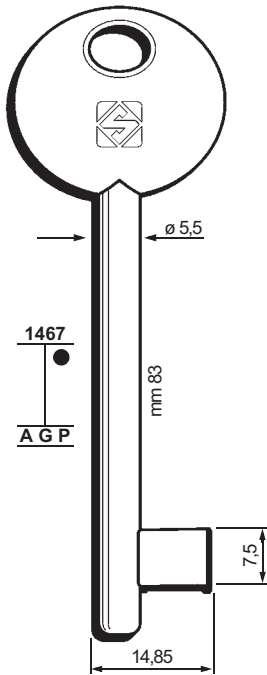

For/Per
OASA
10S
30S
50S
70S
90S



For/Per
OASA
20S
40S
60S
80S
100S

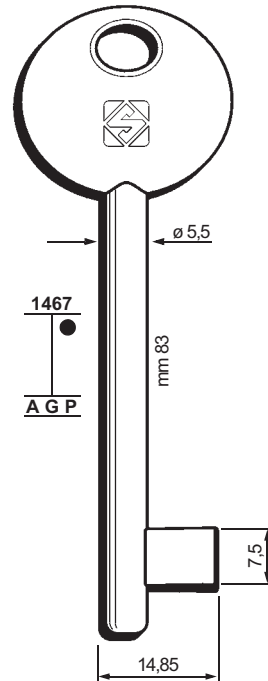

FOR:  
PER:

# OSMET

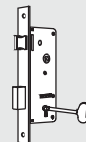

# 153

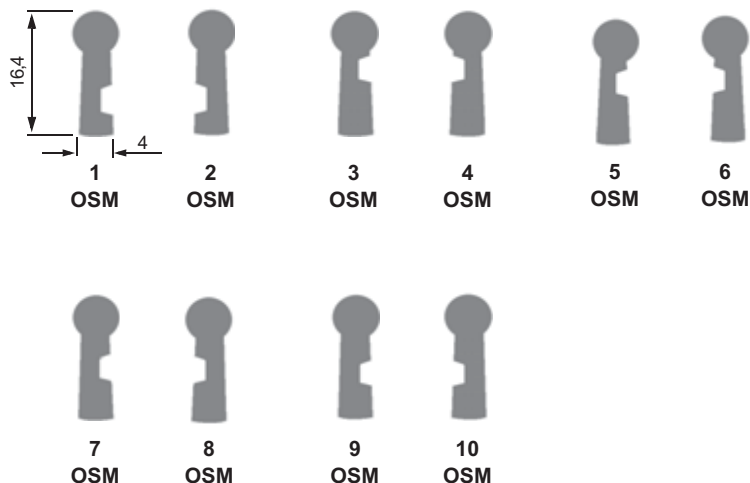
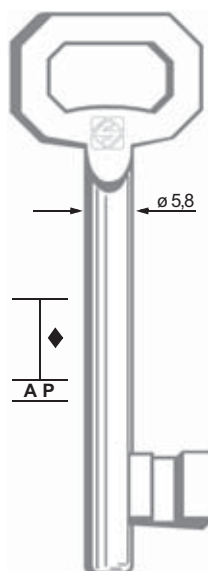

Chiavi obsolete non disponibili a stock - Obsolete keys not available from stock - Überholte Schlüssel, die nicht mehr auf Lager sind - Clés obsolètes non disponibles de stock - Llaves obsoletas no disponibles en stock - Chaves antigas não disponíveis no estoque



Obtainable with: / Ottenibili con:  
Realisierbar mit: / Réalisables avec:  
Obtenibles con: / Conseguível com:

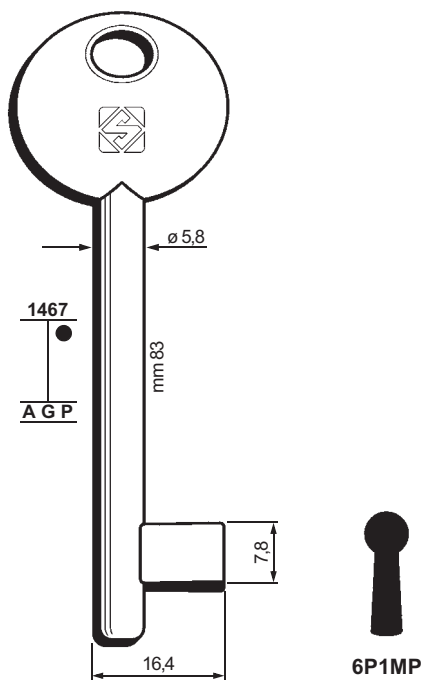

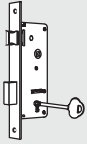

154

FOR:  
PER:

PERINO 6

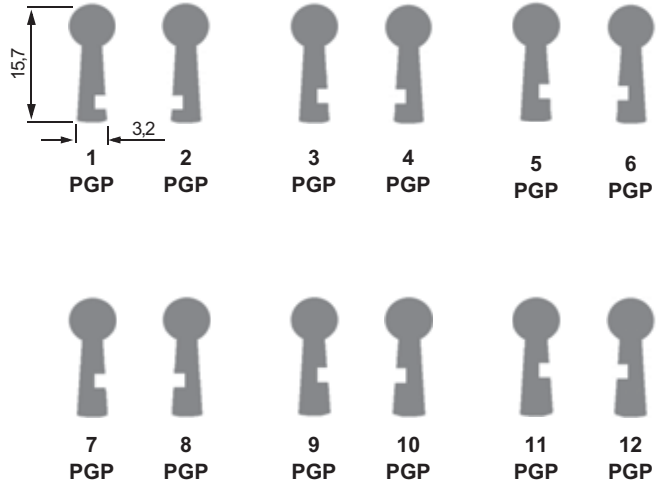
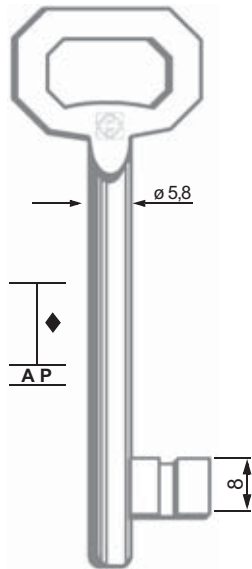

Chiavi obsolete non disponibili a stock - Obsolete keys not available from stock - Überholte Schlüssel, die nicht mehr auf Lager sind - Clés obsolètes non disponibles de stock - Llaves obsoletas no disponibles en stock - Chaves antigas não disponíveis no estoque

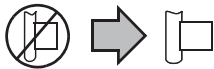

Replaced by: / Sostituite da:  
Ersetzt durch: / Remplacées par:  
Substituidas por: / Substituído por:

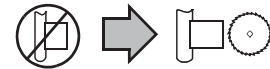

Obtainable with: / Ottenibili con:  
Realisierbar mit: / Réalisables avec:  
Obtenibles con: / Consegúvel com:

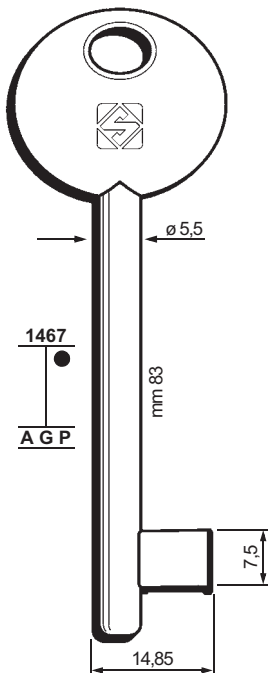

For/Per
PERINO
1PGP
3PGP
5PGP
7PGP
9PGP
11PGP

For/Per
PERINO
2PGP
4PGP
6PGP
8PGP
10PGP
12PGP

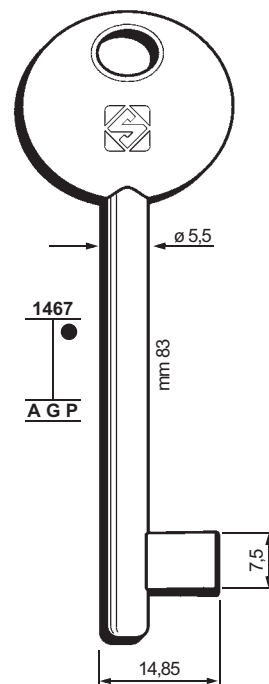

FOR:  
PER:

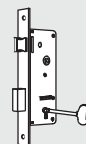

SINA

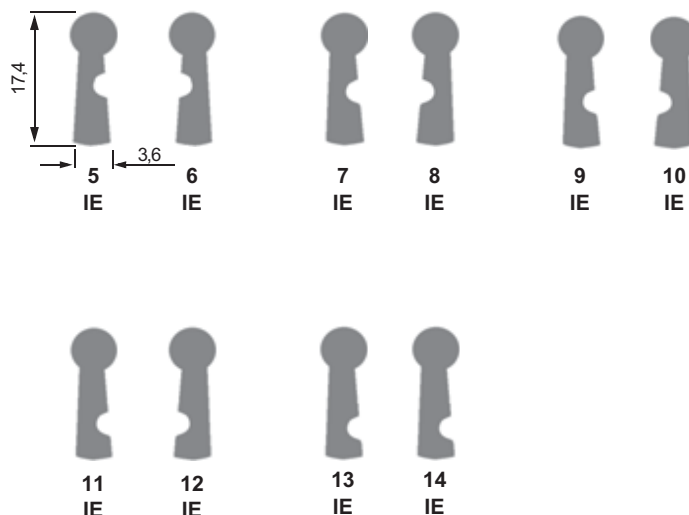
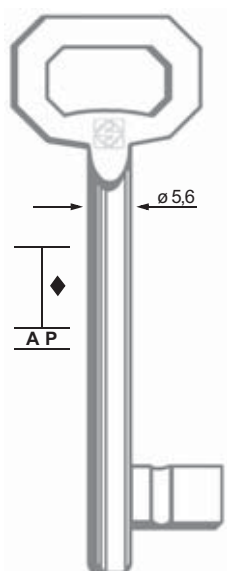

155



Chiavi obsolete non disponibili a stock - Obsolete keys not available from stock - Überholte Schlüssel, die nicht mehr auf Lager sind - Clés obsolètes non disponibles de stock - Llaves obsoletas no disponibles en stock - Chaves antigas não disponíveis no estoque

    
Replaced by: / Sostituite da:  
Ersetzt durch: / Remplacées par:  
Substituidas por: / Substituído por:

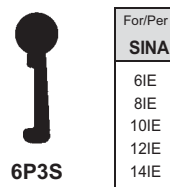
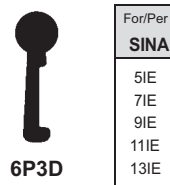
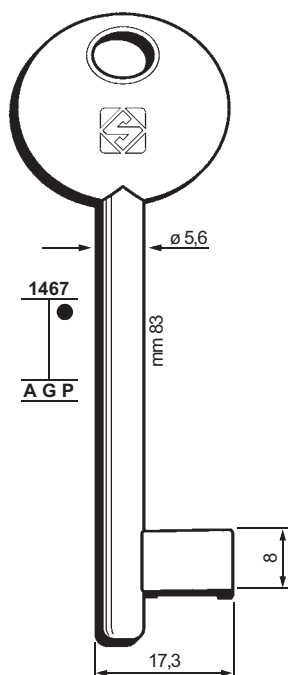

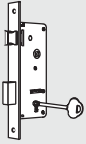

FOR:  
PER:

**SMT**  **8**

**156**

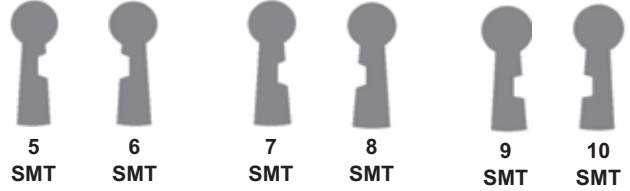
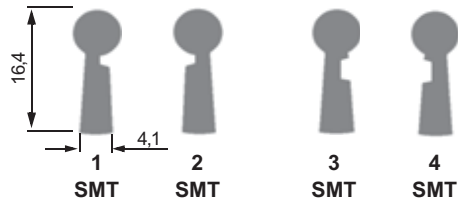
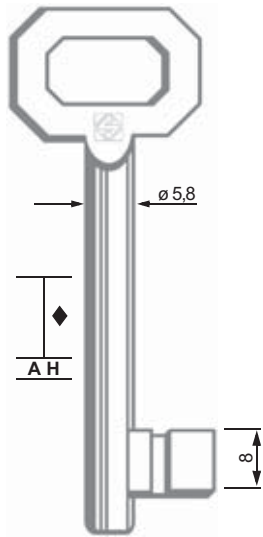

**Chiavi obsolete non disponibili a stock - Obsolete keys not available from stock - Überholte Schlüssel, die nicht mehr auf Lager sind - Clés obsolètes non disponibles de stock - Llaves obsoletas no disponibles en stock - Chaves antigas não disponíveis no estoque**



**Obtainable with: / Ottenibili con:  
Realisierbar mit: / Réalisables avec:  
Obtenibles con: / Conseguível com:**

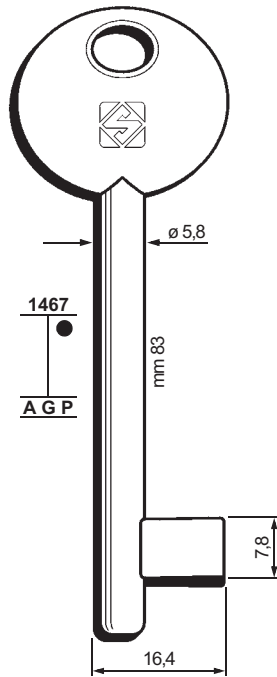

FOR:  
PER:

# STIQAM

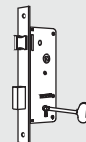

# 157

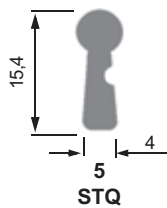
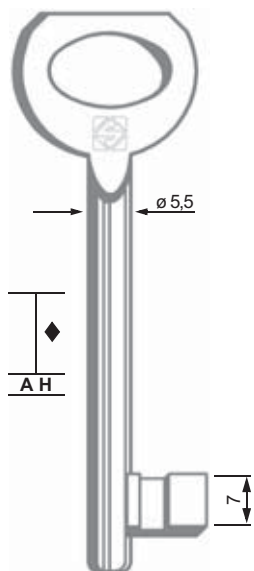

**Chiavi obsolete non disponibili a stock - Obsolete keys not available from stock - Überholte Schlüssel, die nicht mehr auf Lager sind - Clés obsolètes non disponibles de stock - Llaves obsoletas no disponibles en stock - Chaves antigas não disponíveis no estoque**



**Replaced by: / Sostituite da:  
Ersetzt durch: / Remplacées par:  
Substituidas por: / Substituído por:**



**Obtainable with: / Ottenibili con:  
Realisierbar mit: / Réalisables avec:  
Obtenibles con: / Consequível com:**

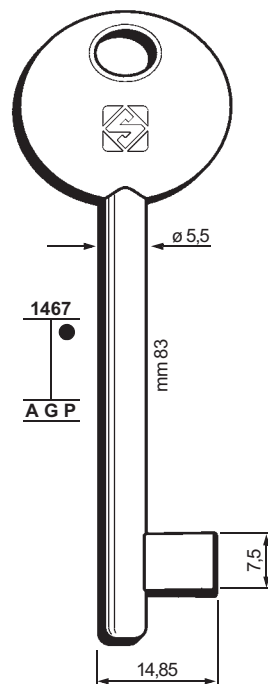
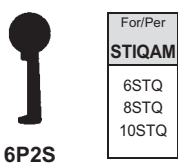
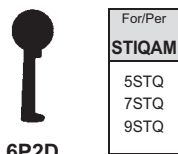
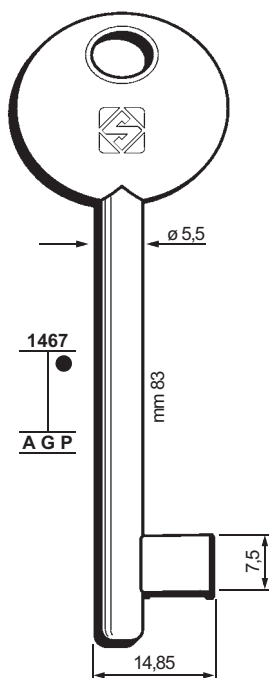

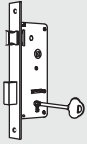

158

FOR:  
PER:

PATENT "Passepartout"

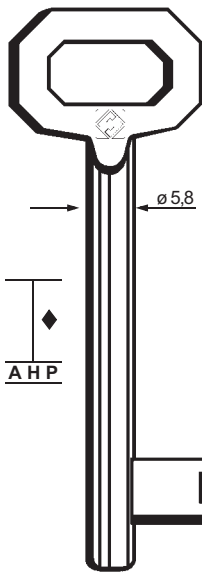

FOR/PER:  
CORNI □ 8 (. . C)  
(. . CCG)  
(. . CCN)



5005C



5006C

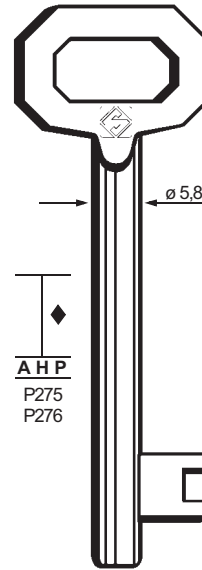

FOR/PER:  
CORNI □ 6 (. . CCP)



5009

PER:  
FOR:

PATENT "Passepartout"

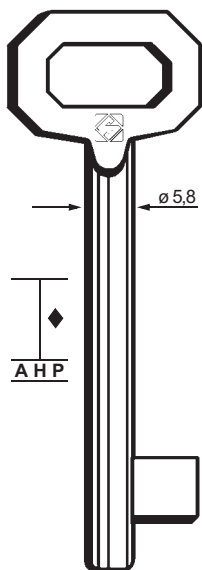

FOR/PER:  
BONAITI (. . GBP)  
ETNA (. . ET)  
MAVE (. . MV)  
MP (. . MPP)  
OASA (. . OS)  
PERINO (. . PGP)

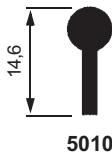

5010

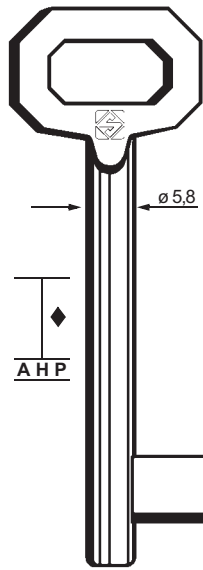

FOR/PER:  
AGB (. . AGB)  
MP (. . MPN)  
PERINO (. . PG)  
SMET (. . SM)

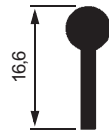

5011

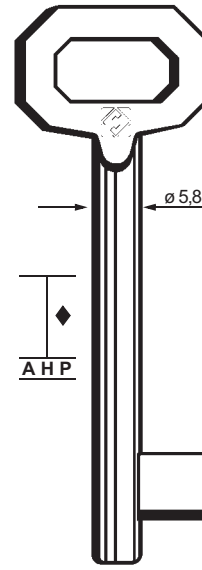

FOR/PER:  
BONAITI (. . GBG)  
ISEO (. . IE)  
MP (. . MPV)

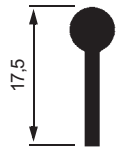

5012



FOR:  
PER:

### PATENT "Passepartout"

### PATENT "tipo vecchio"



# 159

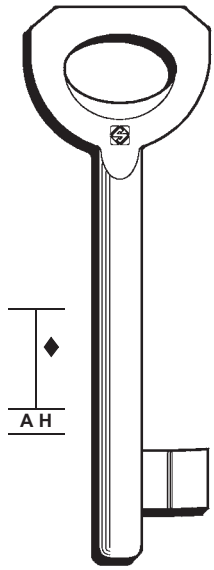

5008EK



5007EK

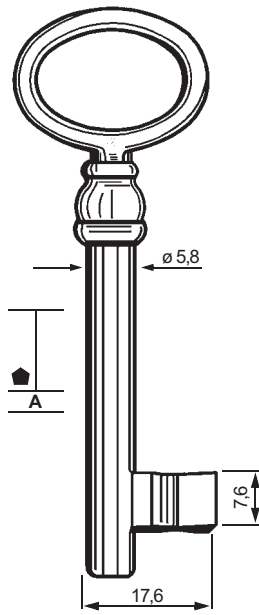

07PV

08PV



13PV

14PV



09PV

10PV



17PV

18PV

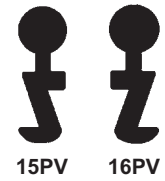

15PV

16PV

FOR:  
PER:

### PATENT "mappa piena"

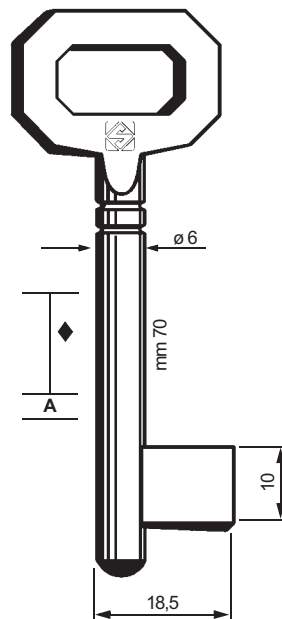

5602

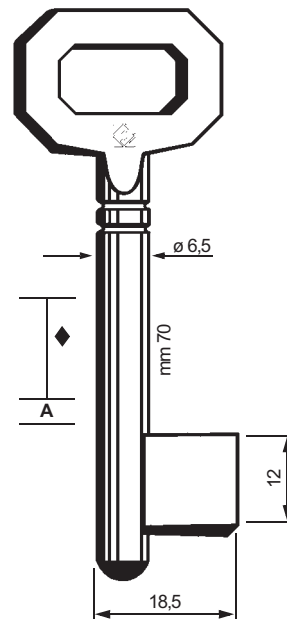

5601

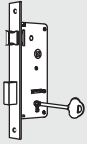

160

FOR:  
PER:

# PATENT "mappa piena"

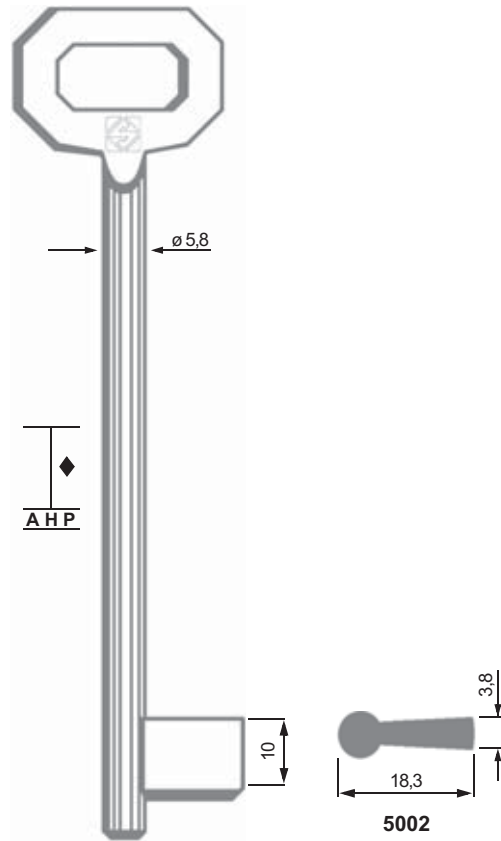

Chiavi obsolete non disponibili a stock - Obsolete keys not available from stock - Überholte Schlüssel, die nicht mehr auf Lager sind - Clés obsolètes non disponibles de stock - Llaves obsoletas no disponibles en stock - Chaves antigas não disponíveis no estoque



Replaced by: / Sostituite da:  
Ersetzt durch: / Remplacées par:  
Substituidas por: / Substituído por:

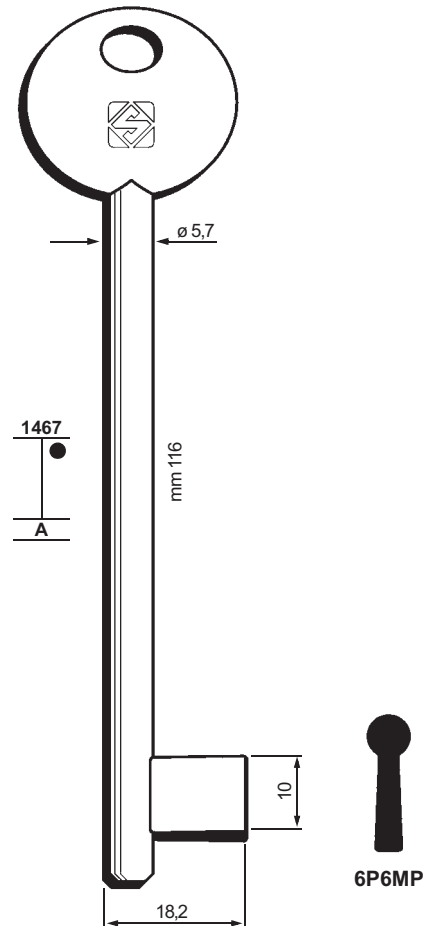

FOR:  
PER:

# Serrature da "CANTINA"

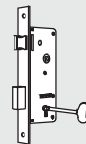

# 161

## CORNI I

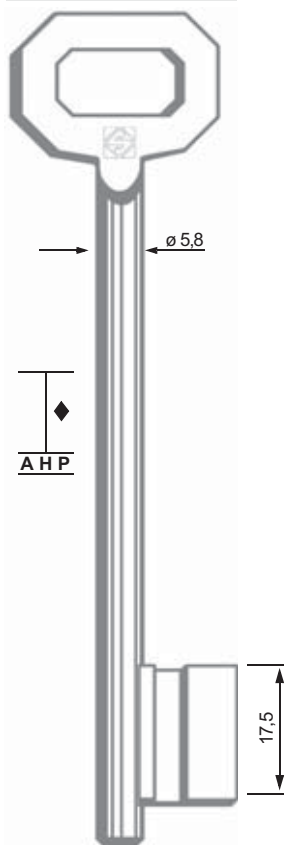

1 STC 2 STC



3 STC 4 STC



5 STC 6 STC



7 STC 8 STC



9 STC 10 STC



11 STC 12 STC



Chiavi obsolete non disponibili a stock - Obsolete keys not available from stock - Überholte Schlüssel, die nicht mehr auf Lager sind - Clés obsolètes non disponibles de stock - Llaves obsoletas no disponibles en stock - Chaves antigas não disponíveis no estoque



Replaced by: / Sostituite da:  
Ersetzt durch: / Remplacées par:  
Substituidas por: / Substituído por:

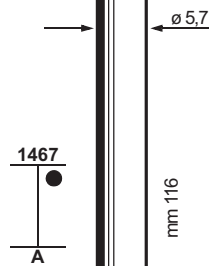

6P7D

For/Per
CORNI
1STC
3STC
5STC
7STC
9STC
11STC



6P7S

For/Per
CORNI
2STC
4STC
6STC
8STC
10STC
12STC



1467  
A

19,15

17,5

mm 116

5,7

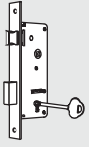

162

FOR:  
PER:

# Serrature "BRONZATE" e da "CANTINA LEGGERA"

BONAITI (I)

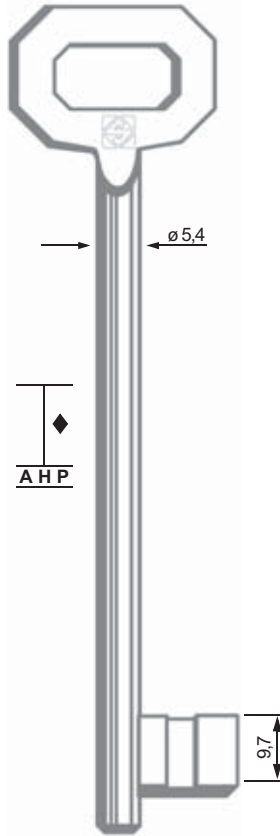

Chiavi obsolete non disponibili a stock - Obsolete keys not available from stock - Überholte Schlüssel, die nicht mehr auf Lager sind - Clés obsolètes non disponibles de stock - Llaves obsoletas no disponibles en stock - Chaves antigas não disponíveis no estoque

Obtainable with: / Ottenibili con:  
Realisierbar mit: / Réalisables avec:  
Obtenibles con: / Conseguível com:

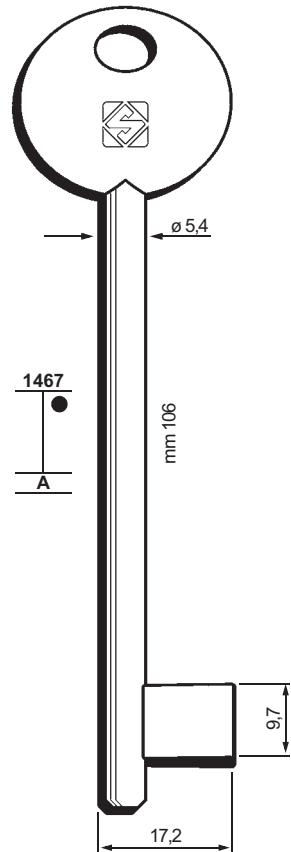

FOR:  
PER:

# Serrature "BRONZATE" e da "CANTINA LEGGERA"

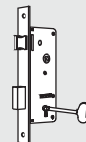

# 163

## MP-CORNI (I)

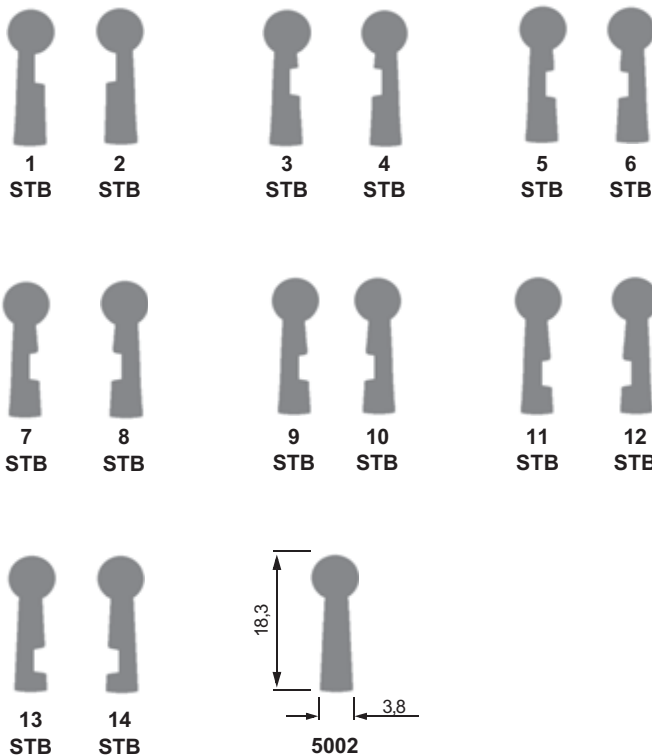
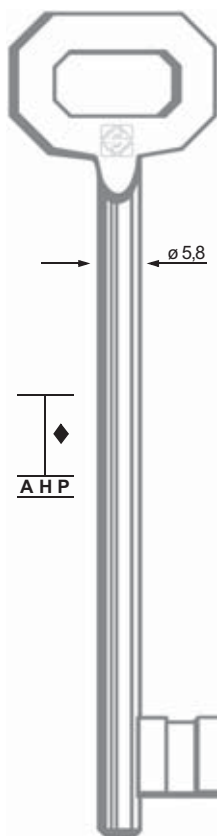

Chiavi obsolete non disponibili a stock - Obsolete keys not available from stock - Überholte Schlüssel, die nicht mehr auf Lager sind - Clés obsolètes non disponibles de stock - Llaves obsoletas no disponibles en stock - Chaves antigas não disponíveis no estoque



Obtainable with: / Ottenibili con:  
Realisierbar mit: / Réalisables avec:  
Obtenibles con: / Consequível com:

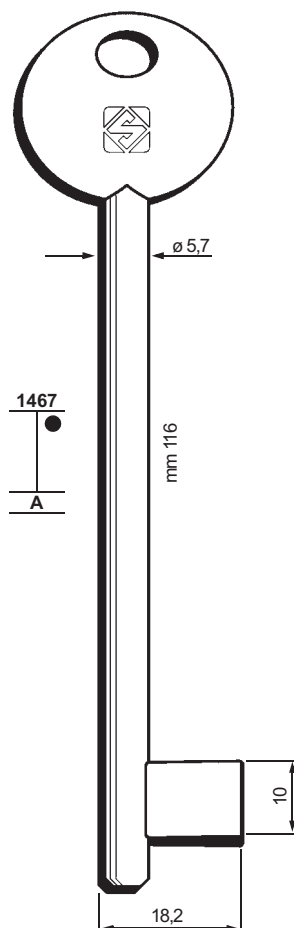

FOR:  
PER:

# Serrature da "Portoncino" BONAITI - "GB" (I)

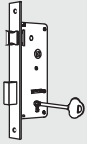

## 164

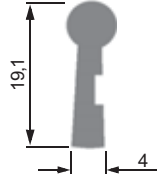
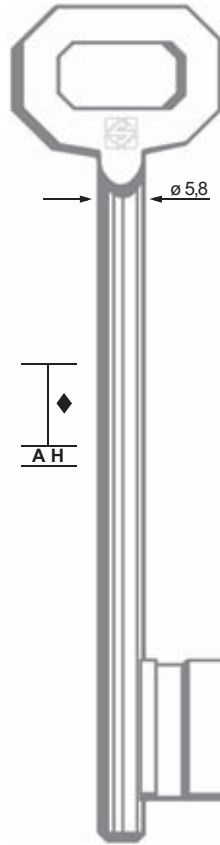

7STC Prof. → A  
9STC C



Replaced by: / Sostituite da:  
Ersetzt durch: / Remplacées par:  
Substituidas por: / Substituído por:

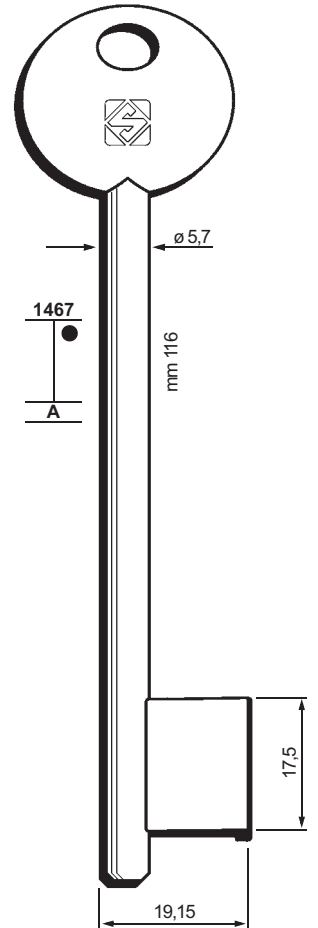

On request they are also supplied with the 14 here below illustrated cuttings; for each cutting 2 profiles.

Su richiesta vengono fornite anche con le 14 cifrature sottoriportate, per ogni cifratura 2 profili.

Nach Bedarf können wir auch mit 14 untergenannten, Chiffreierungen, 2 Profile jede Chiffrierung liefern.

Sur demande elles sont également fournies avec les 14 chiffreages ci-dessous mentionnés; pour chaque chiffreage 2 profils.

A pedido son provistas también con las 14 cifras debajo indicadas, por cada cifra 2 perfiles.

Obtainable with: / Ottenibili con:  
Realisierbar mit: / Réalisables avec:  
Obtenibles con: / Conseguível com:



Cifr. →

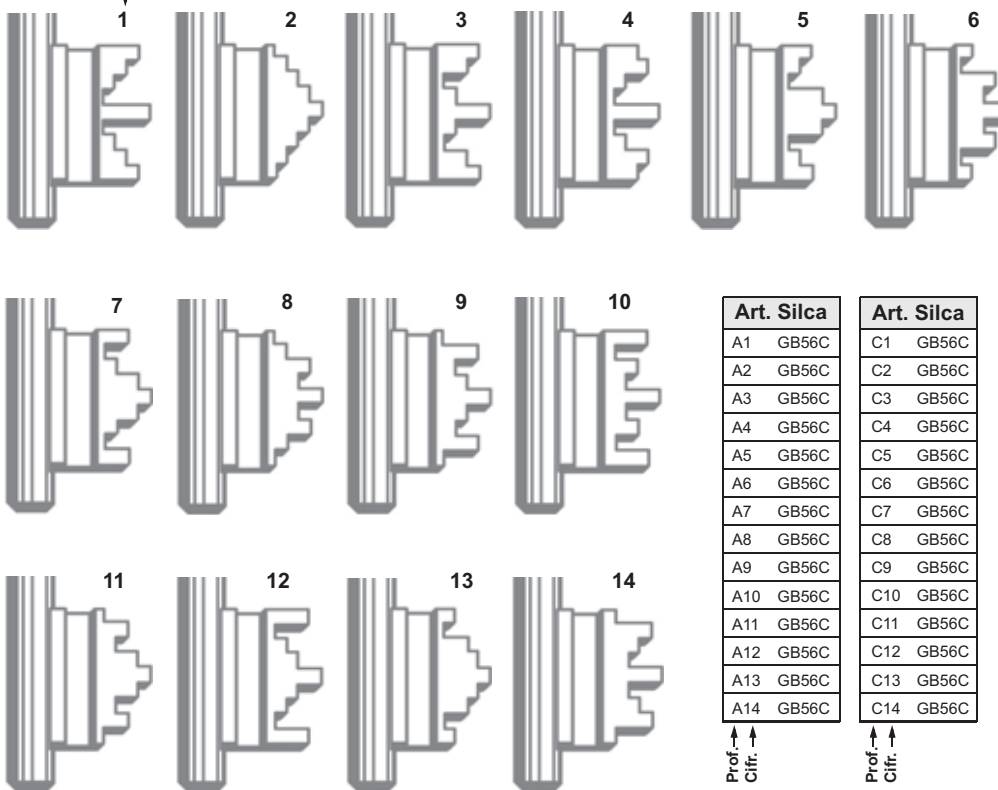

Art. Silca	Art. Silca
A1 GB56C	C1 GB56C
A2 GB56C	C2 GB56C
A3 GB56C	C3 GB56C
A4 GB56C	C4 GB56C
A5 GB56C	C5 GB56C
A6 GB56C	C6 GB56C
A7 GB56C	C7 GB56C
A8 GB56C	C8 GB56C
A9 GB56C	C9 GB56C
A10 GB56C	C10 GB56C
A11 GB56C	C11 GB56C
A12 GB56C	C12 GB56C
A13 GB56C	C13 GB56C
A14 GB56C	C14 GB56C

Prof. ↑  
Cifr. ↑

Prof. ↑  
Cifr. ↑



6P7D

FOR:  
PER:

# Serrature da "Portoncino" BONAITI - "GB" (I)



## 165

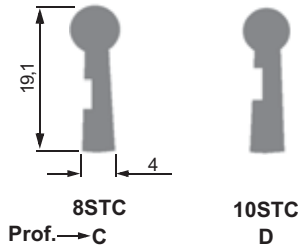
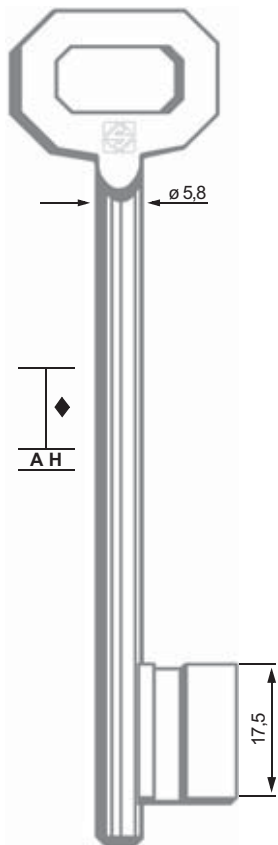

Replaced by: / Sostituite da:  
Ersetzt durch: / Remplacées par:  
Substituidas por: / Substituído por:

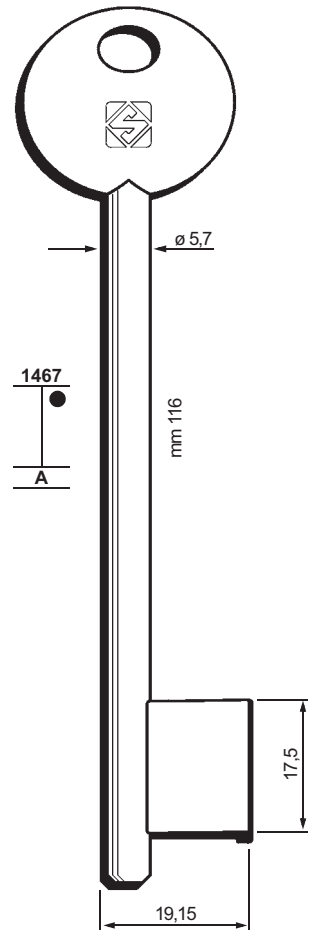

On request they are also supplied with the 14 here below illustrated cuttings; for each cutting 2 profiles.  
Su richiesta vengono fornite anche con le 14 cifrature sottoriportate, per ogni cifratura 2 profili.

Nach Bedarf können wir auch mit 14 untergenannten, Chiffrierungen, 2 Profile jede Chiffrierung liefern.

Sur demande elles sont également fournies avec les 14 chiffrages ci-dessous mentionnés; pour chaque chiffrage 2 profils.

A pedido son provistas también con las 14 cifras debajo indicadas, por cada cifra 2 perfiles.

Obtainable with: / Ottenibili con:  
Realisierbar mit: / Réalisables avec:  
Obtenibles con: / Consequível com:

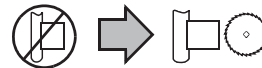

Cifr. →

Art. Silca	Art. Silca
B1 GB56C	D1 GB56C
B2 GB56C	D2 GB56C
B3 GB56C	D3 GB56C
B4 GB56C	D4 GB56C
B5 GB56C	D5 GB56C
B6 GB56C	D6 GB56C
B7 GB56C	D7 GB56C
B8 GB56C	D8 GB56C
B9 GB56C	D9 GB56C
B10 GB56C	D10 GB56C
B11 GB56C	D11 GB56C
B12 GB56C	D12 GB56C
B13 GB56C	D13 GB56C
B14 GB56C	D14 GB56C

Prof. ↑  
Cifr. ↑



6P7S

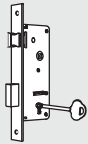

166

FOR:  
PER:

# PATENT Passepartout

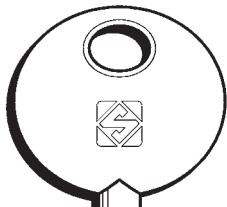

1467  
AGP

ø 5,6  
mm 83

For/Per			
BONAITI	MPV	PERINO	SINA
2GBG	1MPV	1PG	5IE
4GBG	3MPV	3PG	7IE
6GBG	5MPV	5PG	9IE
8GBG	7MPV	7PG	11IE
10GBG	9MPV	9PG	13IE
12GBG	11MPV	11PG	
	13MPV		
	15MPV		
	17MPV		

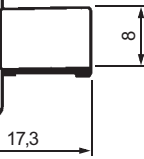

6P3D

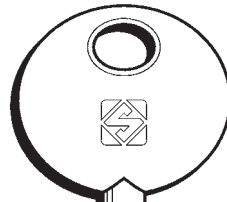

1467  
AGP

ø 5,6  
mm 83

For/Per			
BONAITI	MPV	PERINO	SINA
1GBG	2MPV	2PG	6IE
3GBG	4MPV	4PG	8IE
5GBG	6MPV	6PG	10IE
7GBG	8MPV	8PG	12IE
9GBG	10MPV	10PG	14IE
11GBG	12MPV	12PG	
	14MPV		
	16MPV		
	18MPV		



6P3S

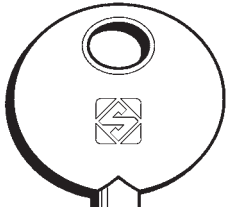

1467  
AGP

ø 5,5  
mm 83

For/Per				
BONAITI	MAVE	OASA	PERINO	STIQAM
2GBP	5MV	1OS	1PGP	5STQ
4GBP	6MV	3OS	3PGP	7STQ
6GBP	11MV	5OS	5PGP	9STQ
8GBP	12MV	7OS	7PGP	
10GBP		9OS	9PGP	
12GBP			11PGP	

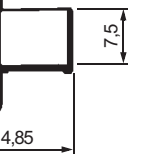

6P2D

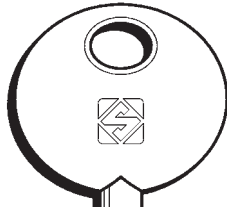

1467  
AGP

ø 5,5  
mm 83

For/Per				
BONAITI	MAVE	OASA	PERINO	STIQAM
1GBP	2MV	2OS	2PGP	6STQ
3GBP	3MV	4OS	4PGP	8STQ
5GBP	8MV	6OS	6PGP	10STQ
7GBP	9MV	8OS	8PGP	
9GBP		10OS	10PGP	
11GBP			12PGP	

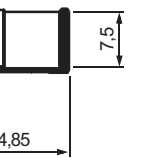

6P2S

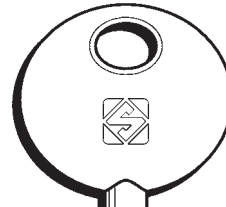

1467  
AGP

ø 5,5  
mm 83



6P2MP

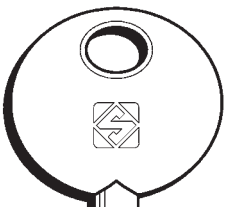

1467  
AGP

ø 5,8  
mm 83

For/Per		
AGB	CORNI	MP
2AGB	1MPN	1MPN
4AGB	5MPN	3MPN
6AGB	7MPN	5MPN
8AGB	9MPN	7MPN
10AGB	11MPN	9MPN
12AGB		11MPN
		13MPN
		15MPN



6P1D

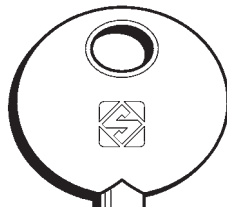

1467  
AGP

ø 5,8  
mm 83

For/Per		
AGB	CORNI	MP
1AGB	2MPN	2MPN
3AGB	6MPN	4MPN
5AGB	8MPN	6MPN
7AGB	10MPN	8MPN
9AGB	12MPN	10MPN
11AGB		12MPN
		14MPN
		16MPN



6P1S

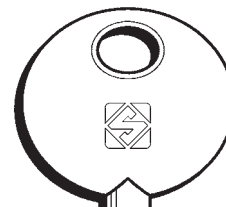

1467  
AGP

ø 5,8  
mm 83



6P1MP



FOR:  
PER:

**PATENT Passepartout**

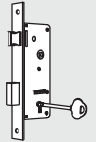

**167**

**CORNI**

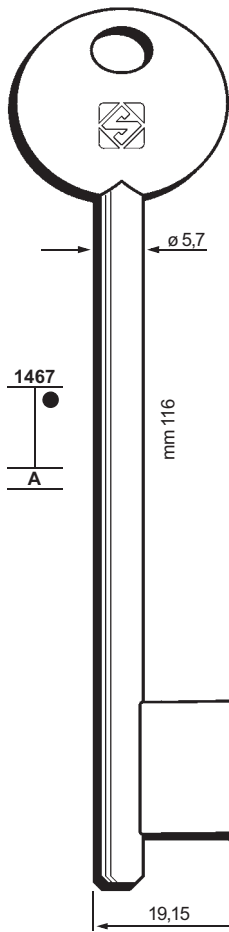

For/Per
<b>CORNI</b>
1STC
3STC
5STC
7STC
9STC
11STC

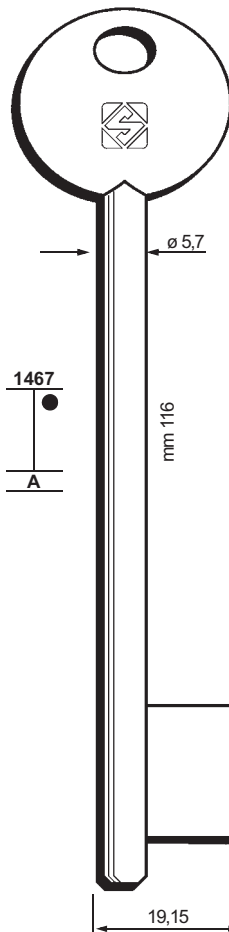

For/Per
<b>CORNI</b>
2STC
4STC
6STC
8STC
10STC
12STC

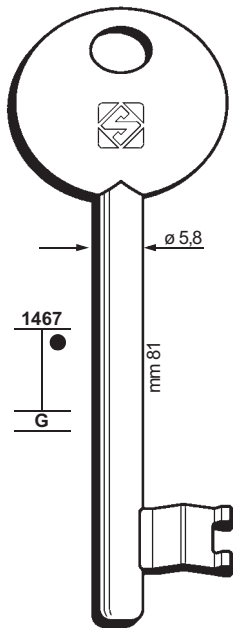

For/Per
<b>CORNI</b>
2CCN
2CCG
2CC
20CC



For/Per
<b>CORNI</b>
1CCN
1CCG
1CC
19CC



For/Per	
<b>CORNI</b>	
3CCN	3CC
9CCN	9CC
3CCG	21CC
9CCG	27CC



For/Per	
<b>CORNI</b>	
4CCN	4CC
10CCN	10CC
4CCG	22CC
10CCG	28CC



For/Per	
<b>CORNI</b>	
6CCN	6CC
7CCN	7CC
6CCG	24CC
7CCG	25CC



For/Per	
<b>CORNI</b>	
5CCN	5CC
8CCN	8CC
5CCG	23CC
8CCG	26CC



For/Per	
<b>CORNI</b>	
11CCN	11CC
13CCN	13CC
15CCN	15CC
11CCG	29CC
13CCG	31CC
15CCG	33CC



For/Per	
<b>CORNI</b>	
12CCN	12CC
14CCN	14CC
16CCN	16CC
12CCG	30CC
14CCG	32CC
16CCG	34CC



For/Per
<b>CORNI</b>
17CCN
17CCG
17CC
35CC



For/Per
<b>CORNI</b>
18CCN
18CCG
18CC
36CC

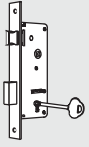

168

FOR:  
PER:

PATENT

EUREKA

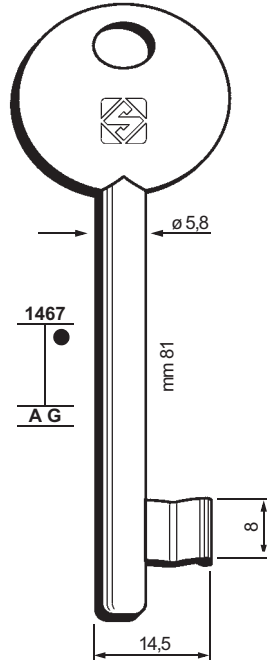

FOR:  
PER:

PATENT "mappa piena"

MP CORNI

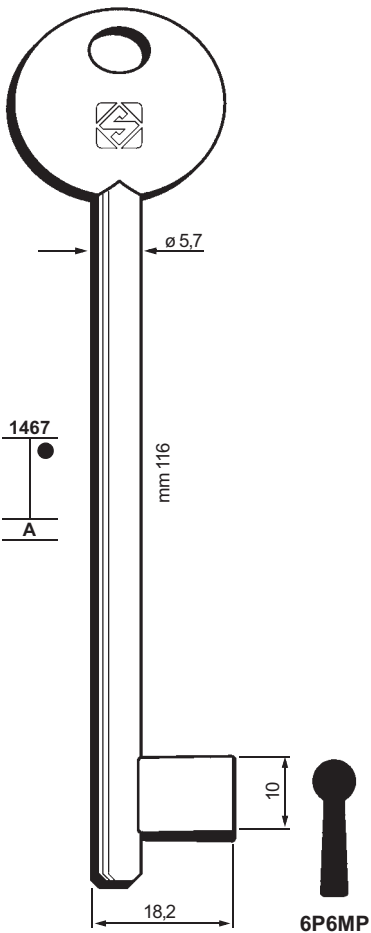

BONAITI

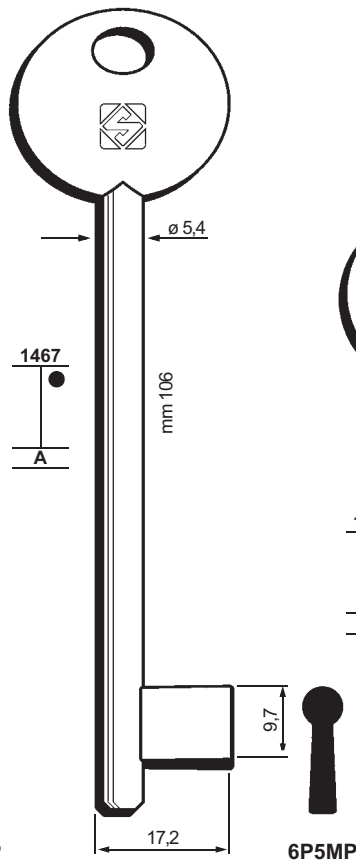

MP

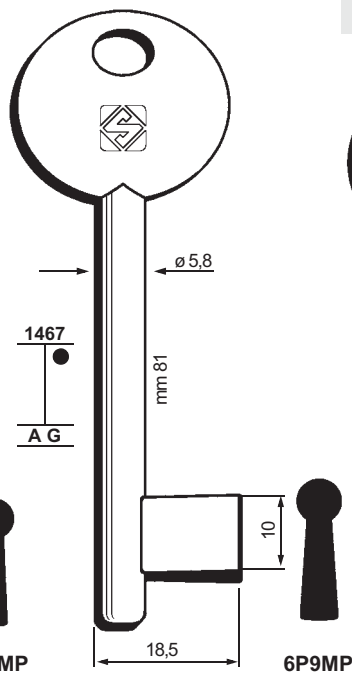

MG (MONTI)

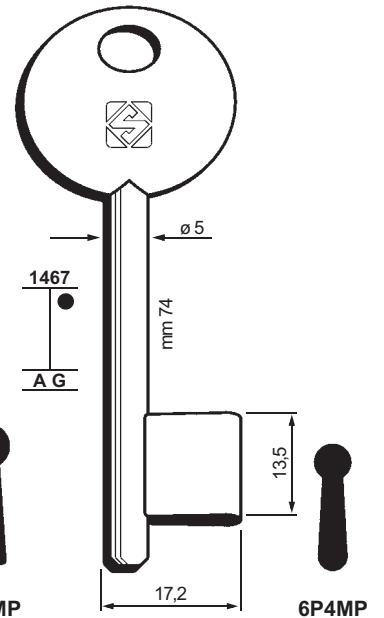



### **GB IMPORTANT**

All information and illustrations in this catalogue are for guidance only.

Silca reserves the right to alter products designs, dimensions or info to improve the products quality.

The contents of this catalogue are fully protected by Copyright and may not be copied or reproduced in any form, without written permission from Silca.

Any infringements will be dealt with under Italian law.

### **F IMPORTANT**

Les illustrations et les caractéristiques techniques des produits présentés dans ce catalogue sont données à titre indicatif.

Bien que les caractéristiques essentielles des produits soient invariables, Silca se réserve le droit d'apporter toutes les modifications qu'elle retiendra nécessaires et opportunes afin d'améliorer la qualité de ses produits.

Tous les dessins et photos sont propriété Silca et toute reproduction, même partielle, sans l'autorisation écrite préalable de Silca est interdite conformément aux prescriptions légales. Tout litige est du ressort exclusif des Tribunaux de la circonscription où se trouve le Siège de la Société.

### **I IMPORTANT**

Le illustrazioni e i dati tecnici dei prodotti contenuti nel catalogo debbono considerarsi indicativi.

Silca si riserva il diritto, ferme restando le caratteristiche essenziali dei prodotti, di apportare tutte le modifiche che ritiene necessarie e opportune al fine di migliorare la qualità dei prodotti.

Tutti i disegni e le fotografie sono di proprietà di Silca, ogni riproduzione anche parziale, senza autorizzazione scritta della Silca è vietata secondo termini di legge.

Per qualsiasi controversia competenti sono gli Uffici Giudiziari dove ha sede l'Azienda, con espressa esclusione di qualsiasi altro foro.

### **E IMPORTANTE**

Las ilustraciones y los datos técnicos de los productos en este catálogo son indicativos.

La Silca se reserva el derecho, quedando invariadas las características principales de los productos, de modificar todo lo que considere necesario y oportuno para mejorar la calidad de sus artículos.

Todos los dibujos y las fotografías pertenecen a la Silca; según determina la Ley, se prohíbe toda reproducción aunque parcial, sin autorización por escrito de la Silca.

En caso de disputas la competencia es de las autoridades judiciales donde está domiciliada la firma, excluyendo cualquier otro foro.

### **D WICHTIG**

Die Abbildungen und technischen Daten des Katalogs sind nur zur Information.

Silca behält sich vor, etwaige Änderungen am Produkt, die zur Verbesserung desselben beitragen vorzunehmen.

Alle Zeichnungen und Fotos sind Besitz der Firma Silca, jede Reproduktion, auch teilweise, ist ohne schriftliche Erlaubnis der Firma Silca gesetzlich untersagt.

Im Falle von Streitfragen ist der Gerichtshof des Firmensitzes zuständig; jeder andere Gerichtshof ist ausgeschlossen.

### **P IMPORTANTE**

As ilustrações e as características técnicas dos produtos apresentados neste catálogo são facultados a título indicativo.

Mesmo que as características essenciais dos produtos sejam invariáveis, à Silca reserva-se o direito de modificar ser necessário e oportuno los productos, afim de melhorar a sua qualidade.

Todos os desenhos e fotos são propriedade da Silca, e é proibida a sua reprodução mesmo parcial sem a autorização escrita da Silca conforme as prescrições legais.

Em caso de litígio fica desde já designado, excluindo qualquer outro, o Tribunal da comarca onde está registada a sede da Silca.



#### **GB IMPORTANT**

In compliance with current regulations relating to industrial property, we hereby state that the trade-marks or trade names mentioned in our catalogue are the exclusive property of authorized manufacturers of locks and users.

Said trade-marks or trade names are nominated only for the purposes of information so that any lock for which our keys are made can be rapidly identified.

This catalogue is reserved exclusively for professional key cutters who use Silca products.

#### **I IMPORTANT**

In conformità alle disposizioni legali in vigore relative alle proprietà industriali, informiamo che i marchi o le denominazioni commerciali citate nel nostro catalogo sono di proprietà esclusiva dei fabbricanti di serrature e degli utilizzatori autorizzati.

Questi marchi o denominazioni commerciali sono indicati a titolo di semplice informazione, con lo scopo di riconoscere velocemente a quali serrature le nostre chiavi sono destinate.

Questo catalogo è esclusivamente riservato ai professionisti della riproduzione chiavi che utilizzano i prodotti Silca.

#### **D WICHTIG**

Gemäß den derzeit geltenden Normen bezüglich des Industrieigentums teilen wir Ihnen mit, daß die im vorliegenden Katalog angeführten Markennamen oder Handelsmarken ausschließliches Eigentum der Schloßhersteller und zugelassenen Fachhändler sind.

Diese Markenbezeichnungen oder Handelsmarken sind nur zur Information angeführt, mit dem Zweck, schnell erkennen zu können, zu welchem Schloß unsere Schlüssel gehören.

Der vorliegende Katalog ist ausschließlich an Schlüsselkopier-Fachgeschäfte, die Silca Produkte benützen, gerichtet.

#### **F IMPORTANT**

Conformément aux lois en vigueur concernant la propriété industrielle, nous vous informons que les marques et appellations commerciales citées dans notre catalogue appartiennent exclusivement aux fabricants de serrures et aux utilisateurs autorisés.

Ces marques ou appellations commerciales sont indiquées à titre d'information pure et simple pour vous permettre de déterminer rapidement les serrures auxquelles nos clés sont destinées.

Ce catalogue est réservé exclusivement aux professionnels du taillage de clés qui utilisent les produits Silca.

#### **E IMPORTANTE**

En conformidad con las vigentes disposiciones de ley sobre propiedad industrial, las marcas y denominaciones comerciales citadas en nuestro catálogo se declaran de propiedad exclusiva de los fabricantes de cerraduras y los utilizadores autorizados.

Dichas marcas o denominaciones comerciales se citan por simple información, al objeto de hacer comprender sin dificultad a qué cerraduras van destinadas nuestras llaves.

Este catálogo está reservado exclusivamente a los profesionales de la reproducción de llaves que utilizan los productos Silca.

#### **P IMPORTANTE**

Em conformidade com as disposições legais em vigor relativas à propriedade industrial, informamos que as marcas ou as denominações comerciais citadas no nosso catálogo são propriedade exclusiva dos fabricantes de fechaduras e dos utilizadores autorizados.

Estas marcas ou denominações comerciais são indicadas só a nível de informação, a fim de reconhecer rapidamente a quais fechaduras se destinam as nossas chaves.

Este catálogo é reservado exclusivamente aos profissionais da reprodução de chaves que utilizam os produtos Silca.